



ff



Fortissimo Success Stories

Fortissimo's Small & Medium, Manufacturing Enterprises

6th Edition

Fortissimo Success Stories
Fortissimo`s Small & Medium, Manufacturing Enterprises
6th Edition, January 2019

Publishers: EPCC and Arctur

Published: in 2019

Edition: 6th

Copyright © 2019 Members of Fortissimo Consortium

Text Copyright © 2019 Members of Fortissimo Consortium

Editor: Members of Fortissimo Consortium

Number of copies: 1000

CIP - Cataloguing in publication
Narodna in univerzitetna knjižnica, Ljubljana

334.012.63/.64:004.77

FORTISSIMO success stories : fortissimo's small
and medium manufacturing enterprises / [editor
members of Fortissimo Consortium]. - 6th ed. -
[Edinburgh] : EPCC ; [Nova Gorica] : Arctur, 2019

ISBN 978-961-94587-0-9 (Arctur)

297767168



Index

- 4 Chapter 1:
About the Fortissimo Project
- 7 Chapter 2:
The Fortissimo Marketplace
- 8 Chapter 3:
Fortissimo Core Partners
- 11 Chapter 4:
Fortissimo Experiment Partners
- 14 Chapter 5:
Fortissimo Success Stories

The research leading to these results has received funding from the European Union Seventh Framework Programme under grant agreement No 609029 and from the European Union's Horizon 2020 research and innovation programme under grant agreement No 680481.



www.ec.europa.eu

www.fortissimo-project.eu



About the Fortissimo Project

The Fortissimo Project was funded by the European Commission within the I4MS initiative (ICT Innovation for Manufacturing Small & Medium Enterprises). It consisted of two phases: the first phase ran from July 2013 to December 2016; the second phase ran from November 2015 to December 2018. The project was coordinated by the University of Edinburgh and involved 23 core partners from different European countries.

THE AIM OF FORTISSIMO

The aim of Fortissimo was to strengthen the global competitiveness of European industry. Fortissimo has encouraged the use of advanced modelling, simulation and data analytics by European Small & Medium Enterprises (SMEs) and midcaps involved in engineering and manufacturing. Such use delivers improved design processes, better products and services and improved competitiveness. For the European Union as a whole, this means increased employment and economic growth.

THE CHALLENGE

In the past, gaining access to the High Performance Computing (HPC) resources required for advanced modelling, simulation and data analytics has often presented significant technical and financial challenges to SMEs. Through the use of HPC resources available via a Cloud-based infrastructure, opportunities leading to business benefits can be identified and applied across the complete value chain saving companies time and money and improving their competitive position.

Joint review of Fortissimo Core Partners.



SME PARTICIPATION

Fortissimo was a collaborative project that enabled European SMEs and midcaps to be more competitive globally through the use of advanced modelling, simulation and data analytics services running on an HPC Cloud-based infrastructure. Fortissimo involved SMEs, midcaps, technical experts, independent software vendors (ISVs) and HPC centres. Ninety-two SMEs participated through "open calls" proposing experiments to demonstrate the benefits of HPC cloud-based advanced modelling, simulation and data analytics. During the 18-month duration of an experiment, the Fortissimo partners provided the participating SMEs with access to HPC-resources via a cloud-based infrastructure and supported them in the planning, implementation and realization of their experiments.

SUCCESS STORIES

The experiments from both phases of Fortissimo resulted in 79 success stories presenting case studies, demonstrating the use of Cloud-based HPC. These case studies were not only relevant to the business needs of end users, but also showed the benefits to all involved in the value chain from end users to the providers of HPC-infrastructure. This booklet presents all of the 79 success stories.

FORTISSIMO DATES AND FACTS

PROJECT NAME	Fortissimo - Factories of the Future Resources, Technology, Infrastructure and Services for Simulation and Modelling
DURATION	1 st phase: July 1 st 2013 - December 31 th 2016 2 nd phase: November 1 st 2015 - October 31 st 2018
TOTAL BUDGET	1 st phase: 21,7 million € 2 nd phase: 11,1 million €
EU CONTRIBUTION	1 st phase: 16,0 million € 2 nd phase: 10,0 million €
CONTRACT NUMBER	1 st phase: 609029 under the 7 th Framework Programme 2 nd phase: 680481 under the H2020 Framework Programme
NO OF PARTNERS	1 st phase: 122 in total (14 Core Partners and 108 Partners in Experiments) 2 nd phase: 96 in total (12 core Partners and 84 Partners in Experiments)
CORE PARTNERS	1 st phase: The University of Edinburgh (EPCC), Arctur, Bull, CESGA, CINECA, GENCI, Gompute, University of Stuttgart (HLRS), INRIA, Intel, Scapos, Sicos BW, SURFsara, Xlab. 2 nd phase: The University of Edinburgh (EPCC), Arctur, Atos, CESGA, CINECA, Gompute, University of Stuttgart (HLRS), Intel, Scapos, Sicos BW, SURFsara, Xlab.
NO OF EXPERIMENTS	1 st phase: 53 in total, 43 resulted Success Stories 2 nd phase: 39 in total, 36 resulted Success Stories



MAP OF SUCCESS STORIES

- Countries of Core Partners
- Countries of Experiment Partners
- Fortissimo Success Story

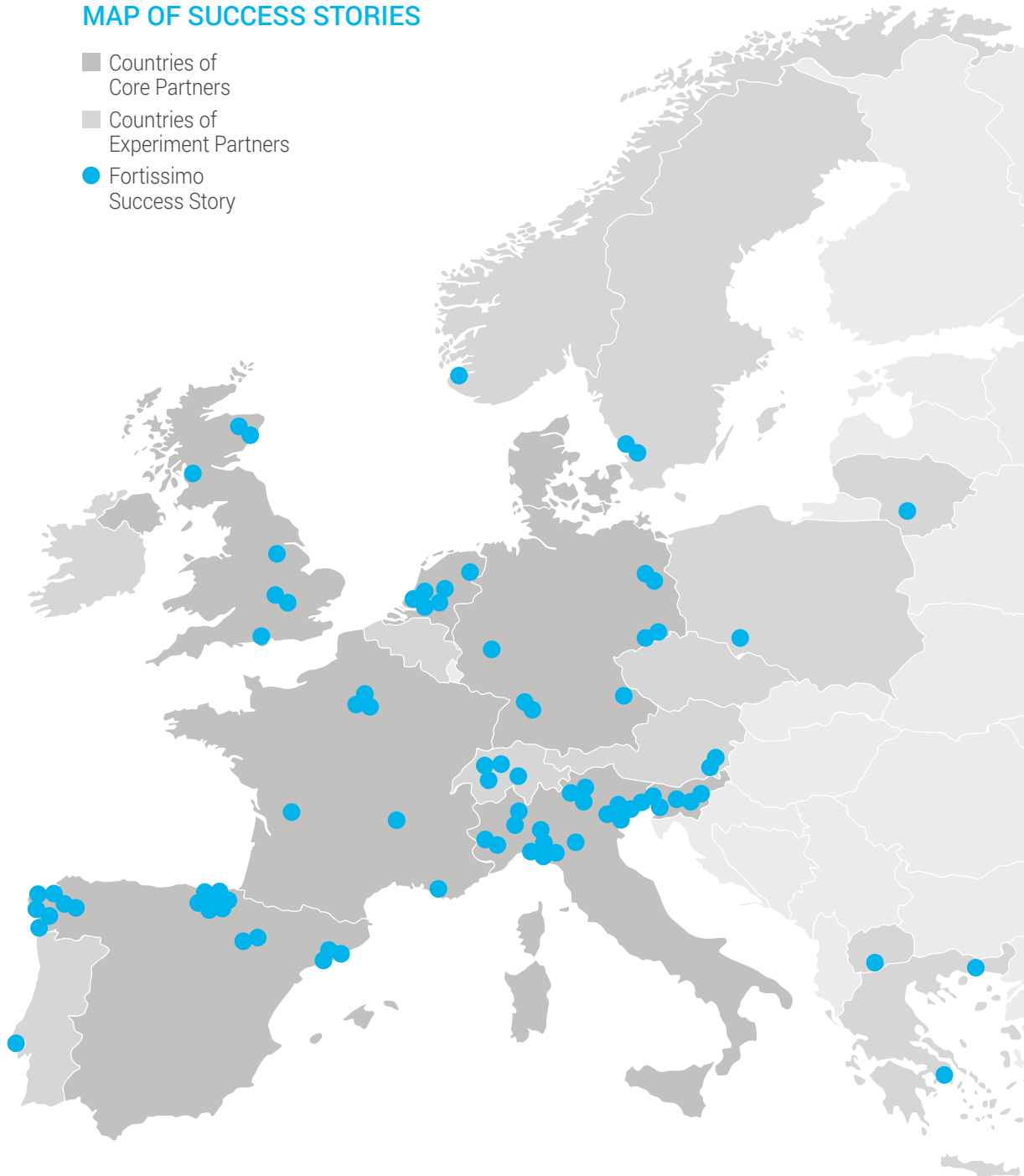

www.fortissimo-project.eu

The Fortissimo Marketplace

HPC is a proven technology in many business applications. Although HPC infrastructure is affordable for large companies, the costs of owning and maintaining it are beyond the financial capabilities of SMEs and mid-caps. The goal of Fortissimo was to overcome this obstacle by providing services and tools running on a Cloud-based infrastructure addressing advanced modelling, simulation and data analytics.

The Fortissimo Marketplace, launched in October 2016, represents an innovative and sustainable commercial ecosystem for simulation, modelling and data analytics. It simplifies access to HPC services for European companies enabling them to be more competitive.

Registration for the Fortissimo Marketplace is free. It offers fast, on-demand and pay-per-use access to HPC services. It matches service providers to users' requirements, handling set up, project management and billing. Such services overcome the need to invest in HPC hardware and software leading to decreased costs and faster time to market particularly for small companies which would otherwise not be able to use HPC solutions.

BENEFITS FOR SMES

The Fortissimo Marketplace offers novel solutions to companies' challenges, enables them to discover new business opportunities and brings together all the necessary actors to construct a solution that matches their business requirements.

The Fortissimo Marketplace enables companies to:

- Greatly reduce time-to-results using pay-per-use SaaS.
- Develop complete and innovative solutions in collaboration with an easily available team with diverse expertise.
- Analyse large data-sets better, pushing any limits far beyond current capabilities.
- Simulate in greater detail and get more reliable results.
- Be ambitious by exploring new ideas.

OPPORTUNITIES AND ADVANTAGES FOR ISVS

The Fortissimo Marketplace is an opportunity to offer enhanced services to customers and reach new markets. By combining software with on-demand HPC resources, Fortissimo allows an Independent Software Vendor (ISV) to offer values-added services that scale up without the need for investing in its own HPC systems.

By joining the Marketplace, an ISV has the opportunity to:

- Offer customers products (as a secure SaaS) on top of one of the most powerful HPC infrastructures in Europe.
- Offer complete solutions working with an easily available team of diverse experts.
- Gain visibility and offer products across the whole of Europe.
- Focus on their core business and profit from optional services such as account management and billing.

www.fortissimo-project.eu



Fortissimo Core Partners

For each Fortissimo experiment one of the Core Partners acted as a provider of High Performance Computing resources and expertise, enabling the other project partners to make best use of HPC in their solution. Providing HPC resources on a pay-per-use basis removes the need for the other partners to invest in their own HPC hardware. The Core Partners benefit by generating income from the services via the Fortissimo Marketplace, and by developing new partnerships with users of those services. This helps keep them at the forefront of innovative support for industry.



THE UNIVERSITY OF EDINBURGH

EPCC is a leading European centre of excellence in advanced research, technology transfer, and the provision of High Performance Computing services to academia and industry.
www.epcc.ed.ac.uk

ARCTUR



Arctur is the leading service provider of supercomputing in Central Eastern Europe. Following the XaaS model, it leases the supercomputer along with the services of system administration, code optimization or parallelization. Arctur delivers HPC services and solutions to industrial and scientific users in various technologically intensive industries.
www.hpc.arctur.net

ATOS



Atos is a leader in digital services, with circa 100.000 employees in 72 countries. Its deep technology expertise and industry knowledge has allowed it to build global client base across many different business sectors.
www.atos.net/en

BULL SAS



The only truly European IT company capable of designing, integrating and implementing supercomputers, Bull has made Extreme Computing one of its key strategic priorities.
www.bull.com/extreme-computing

FUNDACION CENTRO TECNOLOGICO DE SUPERCOMPUTACION DE GALICIA



Fundación Pública Galega Centro Tecnolóxico de Supercomputación de Galicia is a public foundation committed to the advancement of Science and Technical Knowledge, by means of research and application of HPC, communications and other IT resources for the benefit of society.
www.cesga.es

CONSORZIO INTERUNIVERSITARIO

CINECA's mission is to enable the Italian and European research community to accelerate the scientific discovery using HPC resources in a profitable way, exploiting the newest technological advances.
www.cineca.it



GRAND EQUIPEMENT NATIONAL DE CALCUL INTENSIF

GENCI was created with the aim of placing France on the international stage in terms of HPC. Its role is to help implement the national strategy for HPC in support of scientific research within France.
www.genci.fr



GOMPUTE

Gompute is a leading HPC Cloud company, offering expert services and full support to a large number of users worldwide. It delivers comprehensive solutions for High Performance Computing, both in-house and as a service.
www.gompute.com



HLRS – UNIVERSITY OF STUTTGART

The High Performance Computing Centre (HLRS) is one of three national computing centres affiliated to the University of Stuttgart. It operates and provides compute resources to research groups and industry.
www.hlrs.de



INSTITUT NATIONAL DE RECHERCHE EN INFORMATIQUE ET EN AUTOMATIQUE

Over the last 40 years, Inria's researchers have been working at the crossroads of computer sciences and mathematics. Inria is France's only public research body fully dedicated to computational sciences.
www.inria.fr/en



INTEL

Intel (NASDAQ: INTC) is a world leader in computing innovation. The company designs and builds the essential technologies that serve as the foundation for the world's computing devices.
www.intel.com



SCAPOS

Scapos was founded in 2009 for the sales, marketing and support of software for technical computing and of advanced software solutions. Its customers range from large industrial corporations and research institutes to SMEs.
www.scapos.com



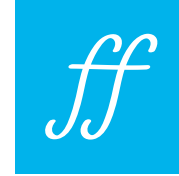

SICOS

Provides access to big data's analysis, simulation and High Performance Computing.

The Sicos BW GmbH, headquartered in Stuttgart, was founded in 2011 by the Karlsruhe Institute of Technology (KIT) and the University of Stuttgart in order to facilitate especially small and medium enterprises (SMEs) access to big data's analysis, simulation and High Performance Computing.

www.sicos-bw.de



SURFSARA

SURFSara supports research, education and industry in the Netherlands in the areas of HPC and Big Data, through the development and provisioning of advanced ICT infrastructure, services and expertise.

www.surfsara.nl



XLAB

XLAB Research is recognized in Slovenia as one of the strongest computer science research teams outside the academic world. Its expertise lies in security and distributed systems.

www.xlab.si

www.fortissimo-project.eu

Fortissimo Experiment Partners





www.fortissimo-project.eu



Fortissimo Success Stories

FORTISSIMO SUCCESS STORIES - 1ST PHASE

- 18 HPC Cloud-based simulation of light-aircraft aerodynamics
[Pipistrel, Slovenia](#)
- 20 HPC Cloud-based simulation of steel casting
[Ergolines, Italy](#)
- 22 HPC Cloud-based design of high-pressure vessels
[Mikrosam, FYR Macedonia](#)
- 24 HPC Cloud-based simulation of flange tightening
[Texas Controls, Spain](#)
- 26 HPC Cloud-based design of high-voltage cables
[Prysmian Group, Italy](#)
- 28 HPC Cloud-based urban planning
[IES, United Kingdom](#)
- 30 HPC Cloud-based optimisation of aircraft wiring
[KE-Works, Netherlands](#)
- 32 HPC Cloud-based prediction of air quality
[Numtech, France](#)
- 34 HPC Cloud-based reduction of vehicle emissions
[AVL, Austria](#)
- 36 HPC Cloud-based simulation of hazardous chemicals
[Lonza, Switzerland](#)
- 38 HPC Cloud-based design of copper-alloy moulds
[IMR, Italy](#)
- 40 HPC Cloud-based simulation of sports-car aerodynamics
[Koenigsegg, Sweden](#)
- 42 HPC Cloud-based design of centrifugal pumps
[EnginSoft, Italy](#)
- 44 HPC Cloud-based simulation of drifting snow
[Binkz, Canada](#)
- 46 HPC Cloud-based molecular modelling
[Albemarle Corporation, Netherlands](#)
- 48 HPC Cloud-based map interpolation for civil engineering
[Sisener Ingenieros, Spain](#)
- 50 Advanced simulation of electromagnetic effects
[Seemi, France](#)
- 52 Advanced simulation of metal casting
[Fundiciones de Roda, Spain](#)
- 54 Simulation of airflow in concentric chimneys
[DINAK, Spain](#)
- 56 High-Performance gear analyzer
[VE&D, Italy](#)
- 58 Simulation of laser-based welding in the automobile and machine tool sectors
[Lasersystemtechnik Bollinger & Ohr, Germany](#)
- 60 Cloud-based simulation of target drug compounds
[Transisight, Germany](#)
- 62 HPC Cloud-based analysis for optical control in manufacturing processes
[EPC, Spain](#)
- 64 Cloud-based processing of seismic data
[Seismic Image Processing, United Kingdom and Sharp Reflections, Norway](#)
- 66 Cloud-based simulation of pipeline components for the oil & gas industry
[Dynaflo Research Group, Netherlands](#)
- 68 Cloud-based environmental modelling
[eAmbiente, Italy](#)
- 70 Cloud-based additive manufacturing
[HSL, Italy](#)
- 72 Advanced simulation for metal forming
[Matrici, Spain](#)
- 74 Optimised cutting and bending of steel reinforcement bars using Cloud-based HPC
[Schnell, Spain](#)
- 76 HPC Cloud-based optimisation of water turbines for power generation
[Zeco, Italy](#)
- 78 HPC-based prediction of the optical properties of dyes
[Scriba Nanotechnologie, Italy](#)
- 80 Multi-physics simulation of high-temperature superconducting devices
[Oxolutia, Spain](#)
- 82 HPC-Cloud-based monitoring of crowds
[DFRC AG, Switzerland](#)
- 84 Cloud-based design of motorcycle helmets
[NolanGroup, Italy](#)
- 86 Simulation of High-Performance composite materials in the automobile industry
[Formtech Composites, United Kingdom](#)
- 88 Cerebral blood-flow simulations
[Vittamed, Lithuania](#)
- 90 Cloud-based simulation of complex fluids
[loniq Technologies, Netherlands](#)
- 92 HPC Cloud-based seakeeping design
[Wavec, Portugal and Vicusdt, Spain](#)
- 94 HPC Cloud-based standard strength assessment of commercial ships
[Isonaval, Spain](#)
- 96 Cloud-based shape optimisation in manufacturing
[Automobili Lamborghini, Italy](#)

- 98 HPC Cloud-based microscopy
[MicroscopeIT, Poland](#); [UZH, Switzerland](#); [OpTecBB, Germany](#) and [Nikon, Switzerland](#)
- 100 HPC based Delft3D service for modelling flooding, morphology, and water quality
[HKV, Netherlands](#)
- 102 Cloud-based simulation of marine communication buoys
[Alseamar, France](#)

FORTISSIMO SUCCESS STORIES - 2ND PHASE

- 104 Cloud-based simulation for vehicle engineering
[Koenigsegg, Sweden](#)
- 106 Optimising gas and flame detector layouts in hazardous manufacturing and production plants
[Micropack, United Kingdom](#)
- 108 Advanced, Cloud-based HPC simulation in the foundry business
[ProService, Italy](#)
- 110 HPC-based design of non-circular gears
[STAM, Italy](#)
- 112 HPC-based high-resolution modelling of magnets
[Magneti Ljubljana, Slovenia](#)
- 114 Cloud-based HPC optimisation of manufacturing processes
[EMO Orodjarna, Slovenia](#)
- 116 Cloud-based HPC processing for knowledge generation in camshaft manufacture
[EPC, Spain](#)
- 118 Cloud-based simulation of box-framed timber beams
[Maderas Besteiro, Spain](#)
- 120 Near real-time analysis of airframe certification test data
[Colosso, Netherlands](#)
- 122 Cloud-based HPC simulation of railway infrastructure for high-speed trains
[Alstom, Italy](#)
- 124 Predictive diagnosis services for the automotive industry
[TEXA, Italy](#)
- 126 Cloud-based simulation of ultra-high-temperature furnaces
[XERION, Germany](#)
- 128 Cloud-based design of yacht sails
[Cape Horn Engineering, United Kingdom](#)
- 130 Cloud-based estimation of marine freight rates
[Vasco Gallega Sociedad de Cartera, Spain](#)
- 132 Simulation of additive manufacturing processes for the production of metal components
[High Performance Engineering, Italy](#)
- 134 Cloud-based design of ultra-clean containers for high-purity chemicals
[Rikutec, Germany](#)
- 136 Cloud-based simulation of the hydrodynamic resistance of ships' hulls in the presence of waves
[CETENA, Italy](#)
- 138 Cloud-based micrositing of small wind turbines
[KLiUX Energies, Spain](#)
- 140 Cloud-based simulation of page curling in the copying of documents
[Bookscanner, Greece](#)
- 142 Data analysis to improve the welfare of laboratory animals
[Tecniplast, Italy](#)
- 144 Cloud-based optimisation of a multi-body wave energy device
[Zyba, United Kingdom](#)
- 146 CAE driven design of a water treatment plant
[Akvola, Germany](#)
- 148 Earthquake resistant design using FE² technique
[Egis Industries, France](#)
- 150 Cloud-based multiphysics simulation for MEMS micro speaker design and development
[USound, Austria](#)
- 152 Improvement of the remote expert system based on software OTEA
[EcoMT, Spain](#)
- 154 Digester 2.0: Optimization of the anaerobic digestion process for biogas generation
[Norvento, Spain](#)
- 156 Cross-solver Cloud-based tool for aeronautical FSI applications
[RINA, Italy](#)
- 158 Large-scale indie gaming analytics (LIGA)
[Kumo Technologies, Spain](#)
- 160 Massively parallel virtual testing of safety-relevant driving systems
[Spicetech, Germany](#)
- 162 The Virtual Engineer 2 – Cloud-based optimisation of production in the dairy sector
[Moody Direct, United Kingdom](#)
- 164 OptiBike robust lightweight composite bicycle design and optimization
[IDEC, Spain](#)
- 166 HPC Cloud-based simulation of coupled electromagnetic and structural-acoustics in in-wheel electric motors
[Elaphe, Slovenia](#)
- 168 Multiphysics icing analysis using HPC Cloud
[MT Propeller, Germany](#)
- 170 Cloud-based multiphysics simulation for designing highly dynamic and highly accurate flow controls for microfluidic applications
[ELVESYS, France](#)
- 172 HemoSphere – prototyping of blood-processing microfluidics in the HPC Cloud
[Aenitis Technologies, France](#)
- 174 Cloud-based simulation of desalination systems powered by renewables
[Photovoltaic, Greece](#)



EXPERIMENT #401 HIGHLIGHTS

Industry Sector:
Aerospace
Country: **Slovenia**
Software used:
OpenFOAM

HPC Cloud-based simulation of light-aircraft aerodynamics



ORGANIZATIONS

Pipistrel is a Slovenian SME. It was established in 1989 and is a leading designer and manufacturer of light aircraft. In order to develop its product line, Pipistrel needs to understand how air flows over its aircraft. For an SME, it is virtually impossible to use wind tunnel tests during the design phase, because such tests are simply too expensive. The only option an SME has is to simulate the flow of air as accurately as possible using a High Performance Computer. To replace wind-tunnel tests satisfactorily, aerodynamic models, which accurately simulate real airflows, need to be deployed. Such models require significant compute cycles and memory.

End User



www.pipistrel.si

HPC Expert



www.xlab.si

HPC Provider



www.arctur.si

THE CHALLENGE

The challenge facing Pipistrel was to perform simulations of the flow over its aircraft in sufficient detail to model real physical effects accurately. Such simulations require expensive computer resources which are normally beyond the means of an SME. However, the use of Cloud-based HPC offers the possibility of running such simulations on a pay-per-use basis which is financially viable for an SME.

THE SOLUTION

The use of Cloud-based HPC allowed Pipistrel to run simulations which accurately predicted how an aircraft would behave in flight. To simulate the air flow around the aircraft with the required degree of accuracy, a large computer model was used. Such a model ran in approximately 2 to 3 days on a Cloud-based HPC system. This enabled Pipistrel to perform complex simulations in a reasonable time and at an affordable cost.

BUSINESS IMPACT

Pipistrel needs to simulate the flow of air over the body of an aircraft only occasionally during the design process. It estimates that it is 10 times cheaper to use Cloud-based HPC simulations than have a suitably powerful in-house system which is only used for part of the time. The indicative annual costs of using Cloud-based HPC simulations are approximately €30.000 compared with an in-house costs of €300.000, which shows that this saving is considerable.

This case study allowed Pipistrel to use HPC for the first time and to learn about its capabilities. Pipistrel ran more demanding, higher fidelity simulations. It gained considerable experience in the use of HPC-based simulation. This experience will help Pipistrel to estimate the time and the cost of such simulations better. This will help them to decide if the use of HPC is justified or not in future projects.

Pipistrel learned that the use of HPC will be very valuable during a design phase of future aircraft. HPC can be used to run much more demanding simulations that improve the fidelity of results. The time needed for such simulations running on an HPC system is roughly the same as the coarser simulations currently run on Pipistrel's in-house cluster. The higher-resolution simulations give more and better data that can be incorporated into each design phase. This both accelerates the design phase and reduces the number of the design cycles.

BENEFITS

- 10 times cheaper to use Cloud-based HPC simulations to having a powerful in-house system.
- Higher resolution of simulations by HPC provide more quality data.
- Design time is reduced by incorporating simulations in each design phase.

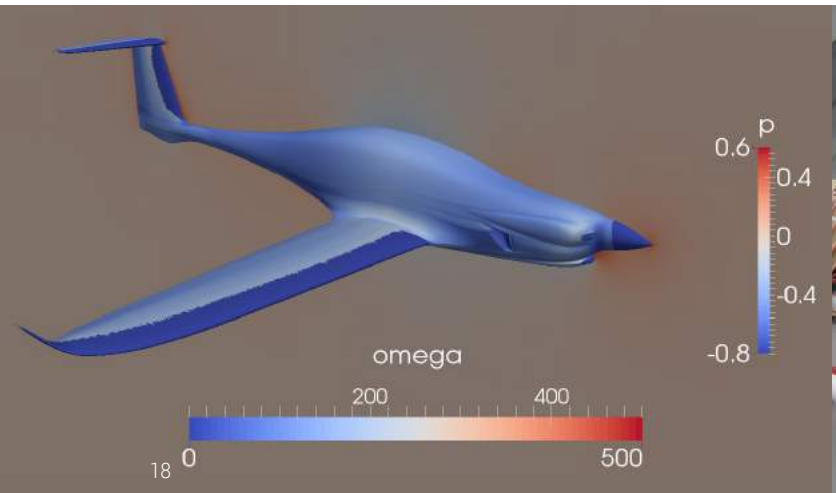



HPC Cloud-based simulation of steel casting

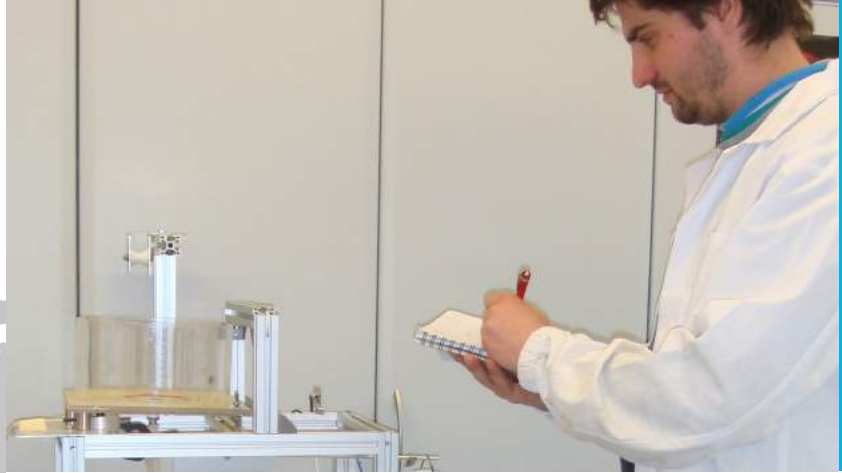

EXPERIMENT #402 HIGHLIGHTS

Industry Sector: **Casting**
Country: **Italy**
Software used: **OpenFOAM**

ORGANIZATIONS

Ergolines is an Italian SME. They are world leaders in manufacturing products used in the production of speciality steels, including special instruments used in continuous casting. Ergolines' goal is to develop equipment which supports production of flawless steel alloys with properties that satisfy an increasingly quality-oriented market. Ergolines routinely uses in-house computational resources during development to simulate the flow of liquid steel as it solidifies. This case study addresses the problem of slag carry-over from the ladle to the tundish, which can lead to impurities in steel or poor ladle yield. This is a complex phenomenon which cannot be observed directly, and simulating it requires the use of HPC, which Ergolines has not previously used.

End User



HPC Expert & Centre



THE CHALLENGE

In continuous steel casting it is crucial to prevent slag (a by-product) from transferring to the tundish. This causes breakouts, resulting in hot liquid steel spraying out – with serious safety and economic implications. An automated system for ladle-slag monitoring is thus in high demand, one which matches the vibration of the slag with the fluid dynamics of the system. This requires detailed simulation, which can only be done using HPC.

THE SOLUTION

HPC simulations gave new insights into the physics of the problem and different ladle-emptying mechanisms. The discovered link between the shroud vibrational signal and the fluid dynamics of the system forms the basis of an innovative monitoring technology, which will significantly improve occupational safety and productivity in steel plants. Ergolines had previously used simulation in its design process, but this was their first experience of using full-scale HPC and seeing its potential benefits.

BUSINESS IMPACT

To get accurate results in complex slag carry-over simulations, it was necessary to use very fine-grained simulations for both geometry and time. This required powerful computing resources that Ergolines did not have. Access to a Cloud-based HPC system thus allowed Ergolines to reduce computational times without incurring the high costs of HPC ownership. The results from the fluid-dynamic analysis enabled development of a new automatic slag detection technology for steel continuous casting, which could bring significant improvements to occupational safety and productivity of steelworks.

The ability to detect slag while it is passing through the shroud enables a steel plant to control the closing of the ladle more finely. For an average ladle size of 100 tons, 0.5 - 1% of steel usually remains in the ladle. With the new monitoring technology, 60% of the lost steel can be saved. On an average production of 1 million tonnes of per year, a medium-size factory could avoid re-melting 6,000 tonnes of steel. Re-melting 6,000 tonnes of steel at approximately €70 to €100 per tonne represents a saving of €420,000 to €600,000. The loss of a further 300 tonnes of steel could be also avoided, saving 70,000€, for total savings of up to €670,000 per year, per medium-sized plant. Casting is a high-energy process, so on top of the monetary savings, energy savings for steel plants equipped with the monitoring technology would be significant.

BENEFITS

- The computational times significantly reduce due to the Cloud-based HPC services.
- Occupational safety and productivity improve with the new automatic slag detection technology developed during the experiment.
- 60% less steel is wasted with the new monitoring technology, which represents energy and monetary savings of up to €670,000 per year.

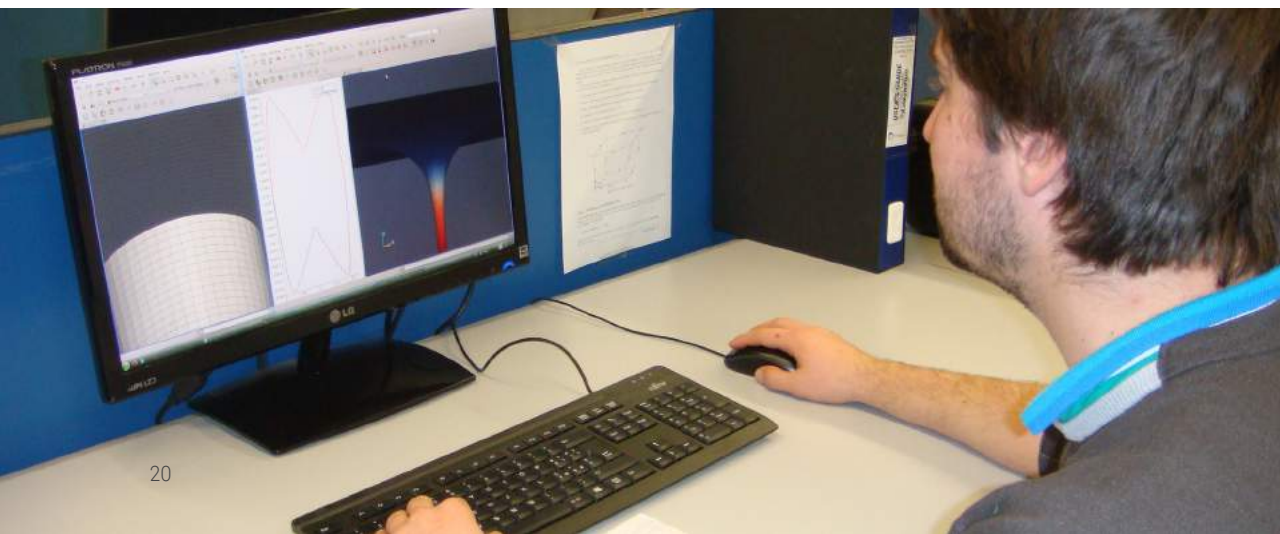



HPC Cloud-based design of high-pressure vessels

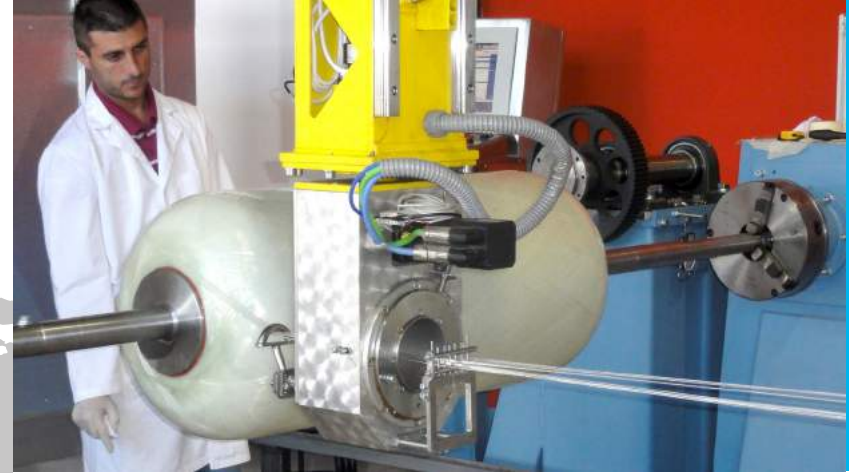

EXPERIMENT #403 HIGHLIGHTS
Industry Sector: **Composites**
Country: **FYR Macedonia**
Software used: **OpenFOAM**

ORGANIZATIONS

Founded in 1991, Mikrosam is an SME, which manufactures winding machines for the construction of composite pressure vessels such as natural gas containers in automobiles. It is involved in the design of pressure vessels and the development and adjustment of its machines to produce such designs. The biggest advantage of modern composite materials is that they are many times lighter than and yet as strong or stronger than widely used metals. Composite materials have the potential to replace widely used steel and aluminium, often with better performance. Composite components can lead to weight savings of between 60% to 80% by replacing steel components and between 20% to 50% by replacing aluminium components.

End User	HPC Provider
 www.mikrosam.com	 www.arctur.si

THE CHALLENGE

Previously for Mikrosam, design involved physical tests. To replace physical tests with numerical simulation requires significant computing resources. An HPC-based system is necessary to get results in a reasonable time frame. The challenge was to develop a model for the simulation of composite materials and to implement it on an HPC system which would enable accurate results to be obtained within an acceptable development time.

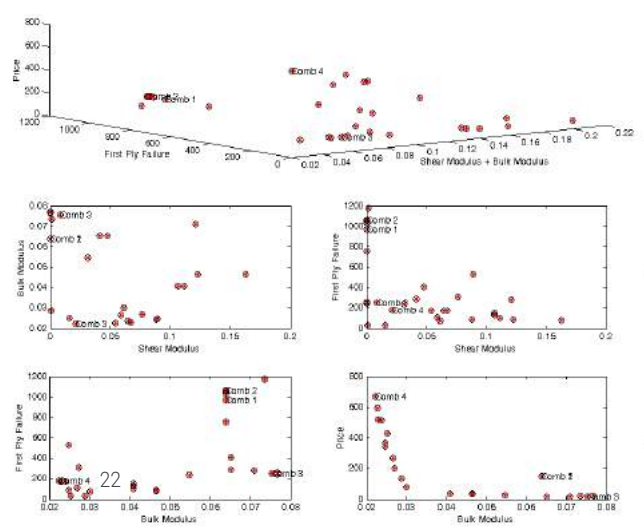

THE SOLUTION

A HPC-based computer model was developed to simulate the behaviour of composite materials using an open-source software package. This model needed significant computing resources and ran on an HPC system. Such simulations reduce the amount of physical testing needed in the design of composite materials. Previously Mikrosam was using simulation in its design process. However this case study was their first experience of HPC and the benefits it could bring.

BUSINESS IMPACT

For each filament winding machine used in the production of high-pressure vessels, different combinations of materials and winding angles for the composite, need to be considered. With the simulation code developed in this case study it is possible to shorten the design time and to reduce the number of physical tests and prototyping costs. The case study has shown that using simulation on an HPC system can reduce time for composite design by about 30% and reduce the cost of design and testing by 10%. As a result of the Fortissimo experiment, Mikrosam will be able reduce its production costs by about €30.000 per year for the next 5 years. More importantly its product offer (production machines for high-pressure vessels) will give each of its customers an advantage in production costs of around €300.000 per year per machine for machines that are currently on the market. The considerable advantage of Mikrosam's products over those of its competitors will, as a conservative estimate, lead to an increased revenue for the company of around €400.000 per year for the next 5 years. This is a significant amount for this SME. The experience gained in this experiment together with reduced production costs for both Mikrosam and its customers constitutes a base for further growth of the company and the resultant creation of new jobs.

BENEFITS

- Reduced design time by 30%.
- Reduced number of physical tests and prototyping costs.
- Reduced production costs by about €30.000 per year for the next 5 years.



EXPERIMENT #404 HIGHLIGHTS

Industry Sector:
Mechanical Engineering

Country: **Spain**

Software used:
code_aster

HPC Cloud-based simulation of flange tightening



ORGANIZATIONS

Texas Controls is a Spanish SME offering tightening and sealing solutions to large industrial facilities in a number of sectors. These are especially important to customers in the oil and gas industry, where it is imperative to avoid leaks in pipes, pressure vessels, or reactors that are under extreme pressures and temperatures. In these situations, preventing leaks is much less costly than dealing with consequences of one. It is crucial to be able to predict the behaviour of flanged joints, and to understand elastic interactions between them. Texas Controls has used computer simulations previously, however, the computational demands of modelling the behaviour of flanges were high, and so an HPC-based solution was necessary. This was the first time they had used such technology.

End User

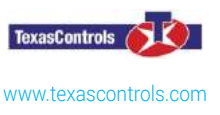

Domain Expert



HPC Centre & Expert



THE CHALLENGE

To seal a joint properly, a gasket is placed inside a groove located on both flanges. The challenge here was to simulate and optimise tightening of the flanges - during the closing and tightening process, the gasket and the flanges may be damaged through deformations and high levels of stress. If the joint is damaged, it could fail, which could seriously harm workers, the surrounding community, and the environment.

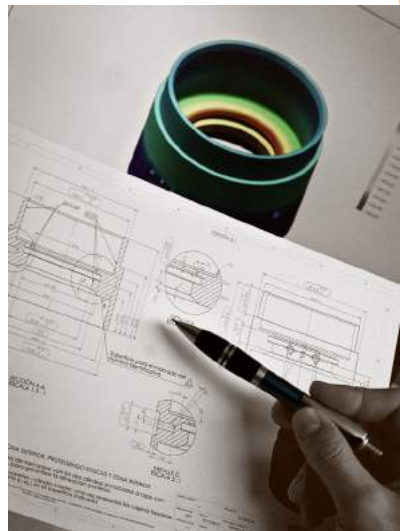
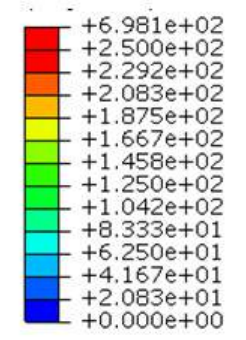
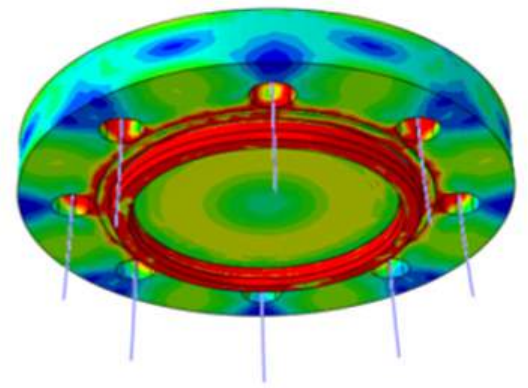

THE SOLUTION

A computer model was developed which represented all the functional parts of a flange, including the gasket and the tightening bolts. This model was driven by a user interface, which enabled different tightening scenarios to be evaluated. Using the model, Texas Controls could accurately simulate and improve the design of the tightening process. The model was implemented using both open-source and proprietary simulation codes. Several sizes of case studies were run.

BUSINESS IMPACT

Based on previous experience in the field (when no simulations were carried out), a non-optimised tightening of a 24 stud bolt flange took 108 man-hours; using simulation, Texas Controls reduced the process to 72 man-hours - a 33% time saving per flange. Whilst this represents considerable savings in labour costs, the most important outcome is the reduction in downtime of industrial installations such as refineries. The cost of "down time" for a medium-sized hydrocracker is about €21.000 per hour (€500.000 per day). Using advanced simulation, flange tightening can be reduced from 27 hours to 18 hours. This means a saving to the end-user of ~€180.000, because the shutdown path is shortened by the same amount that the tightening process is optimized. HPC-based simulation also allows technicians to avoid damage to flanges during the tightening, which is not possible using the usual experience-based method. This can also have significant cost implications. These benefits give Texas Controls a significant competitive advantage in a highly technical industrial sector, which should result in winning major, international commissioning contracts. This is expected to result in an increase in revenue of €2 million over the next 3 years, and a related 15% increase in staff employed. Texas Controls has a range of other services where the use of cloud-based HPC tools have the potential to similarly enhance Texas Controls' competitive advantage.

BENEFITS

- 33% time saving per flange for Texas Controls.
- Optimization of flange tightening process.
- Increased revenue of €2 million over the next 3 years.



HPC Cloud-based design of high-voltage cables

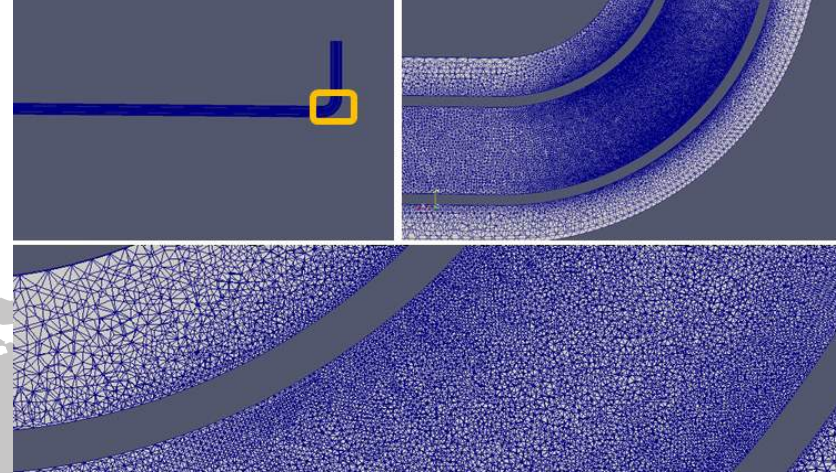

EXPERIMENT #405 HIGHLIGHTS

Industry Sector:
Electrical Engineering

Country: **Italy**

Software used:
COMSOL



ORGANIZATIONS

Prysmian Group is a world leader in the development and supply of energy and telecom cables and associated systems. Prysmian Group develops underground and submarine power cables in the energy sector, and medium- and low-voltage cables for the construction and infrastructure industry, and so need to model the physical behaviour of high-voltage power-transmission cables. Prysmian has a clear business requirement to scale-up its current simulations of energy cables and systems to a larger refinement and size, which exceeds the computing power available in-house. Prysmian would also like to undertake more ambitious simulations, requiring new competencies and tools. The demonstration of a successful, cost-effective cloud-based HPC simulation would be a breakthrough for Prysmian.

End User



www.prysmiangroup.com

HPC Expert & Service Provider



www.cineca.it

THE CHALLENGE

Prysmian has used a standard modelling package for several years as its main tool for electromagnetic simulations, using 2D models on a few high-end workstations. However, finer simulations were needed, which were achieved using Cloud-based HPC to create a 3D model, and addressing how improved simulations could be exploited in a future business model. Another goal was to use open-source software in these simulations, to avoid expensive licences.

THE SOLUTION

Both the third-party and open-source simulation packages were ported to a Cloud-based HPC system. The resultant simulations enabled Prysmian to improve calculation of losses inside energy cables, especially those induced by the magnetic field due to the load current. Prysmian is also able to better model the heat transfer from the cable to the environment. This has improved their design capability significantly – 2D simulations have been replaced by much more realistic 3D simulations on the HPC system.

BUSINESS IMPACT

The business benefits from the use of a Cloud-based HPC system arise from several sources. The move from the previous 2D model to an advanced 3D model enables much better cables to be designed. This allows Prysmian to retain the competitive edge needed to remain market leader with a time to market independent of the increase in complexity of the design process. The need for Cloud-based HPC simulation is of the utmost importance in this case study. Cloud-based HPC modelling has enabled better, more detailed simulations to be made in a shorter time. Running such simulations would not be feasible on a network of workstations, so previously Prysmian did not have this capability.

Prysmian estimates that the use of a Cloud-based HPC system instead of investing in an in-house system can provide savings of around 30% per annum in costs for cycles alone. This is based on the costs of the cycles needed to run the simulations in the HPC-Cloud compared with the costs of a suitable HPC computer system which would cost €150.000, amortised over 3 years with additional annual operational costs of €40.000. Further savings were also identified through the use of expertise on-demand at the computer centre rather than through the employment of a member of staff with the necessary expertise in simulation.

BENEFITS

- Move from 2D model to 3D.
- Better and more detailed simulations in a shorter time.
- Savings around 30% per annum in costs for cycle alone.





HPC Cloud-based urban planning

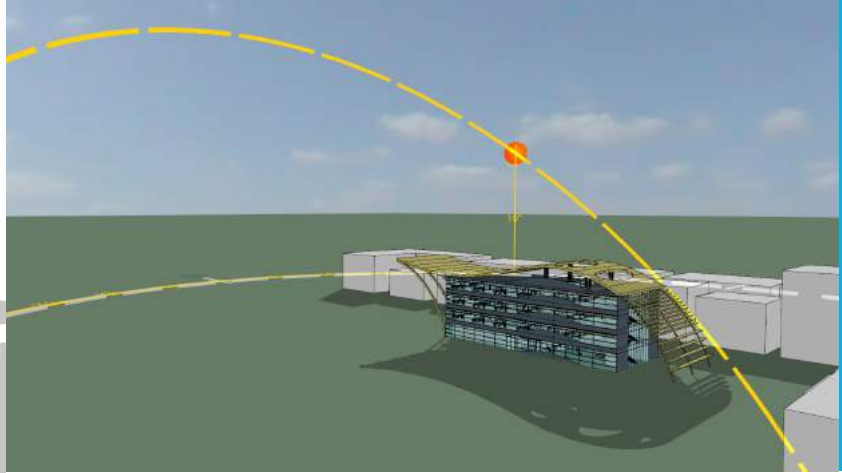

EXPERIMENT #406 HIGHLIGHTS
Industry Sector: **Urban Planning**
Country: **United Kingdom**
Software used: **In house code**

ORGANIZATIONS

Founded in 1994, IES is an SME based in Scotland. IES develops the world's leading integrated building-performance modelling software system, designed to enhance building performance and create more sustainable buildings. The IES's Virtual Environment (VE) is a suite of tools based around a single integrated data model. IES provides leading-edge support for the design, construction and operation of some of the largest, most challenging buildings in the world. Based on its VE, IES has developed a planning tool for cities, which will enable stakeholders to assess the energy efficiency of a city, quality of living, etc. The tool can be used in cities just beginning the journey towards a 'smart' city, or those that are well on their way towards integration with 'smart' technologies.

End User, Application Expert & ISV



HPC Provider & Expert



THE CHALLENGE

The purpose of IES's VE is to provide the information required to design, build and operate better performing, more sustainable communities. The planning tool based on the VE relies heavily on HPC cloud-based simulation, because of the amount of data generated by multiple buildings. A major objective here was to enable VE desktop installs and web-based interfaces to access calculation resources hosted on an HPC Cloud infrastructure.

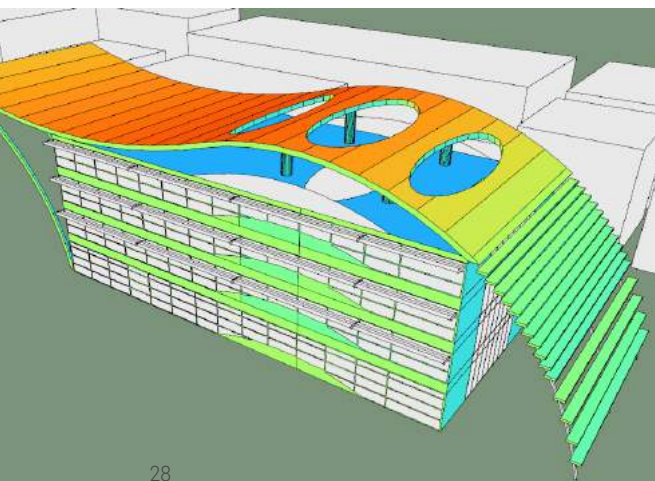

THE SOLUTION

IES's planning tool addresses large simulations quickly and effectively through Cloud-based HPC, but uses a familiar workstation for data display. This case study has proved to be very significant for IES. Simulations run from personal workstations or company servers were often long and tedious, with the consultant having to wait for results to be available. A cloud-based HPC approach significantly decreased the run-time of simulations whilst substantially increasing the number of buildings per simulation.

BUSINESS IMPACT

In this case study, model simulations ranging from the small to the very large were tested. Typical speedups (comparing the workstation to the HPC system) were between 5 and 10 times faster for the HPC system. The major benefit of this is that simulations, which previously had unrealistically long compute times of days or weeks on the workstation, could be run in a few hours or days using the Cloud-based HPC system. As IES's VE is used today by many of the world's leading architectural and engineering practices, this has clear commercial benefits. Indeed, based on the successful experiment, IES is now offering an HPC-based service to its customers. This service embodies a pay-as-you-go approach which is underpinned by HPC-systems available from EPCC, the HPC centre of the University of Edinburgh.

A 64-core in-house system costing £33,000 would have an annual running cost of around £22,000 (support, maintenance, electricity, housing, etc.). Amortised over three years, this gives a total cost per core hour of £0,10, compared with a cost of £0,05 for Cloud-based HPC cycles – already a 50% saving. Cloud-based HPC looks even more cost effective when it is considered that an in-house system would never be used continuously, and so would be even less competitively priced than this calculation indicates.

BENEFITS

- Ability to model much larger structures.
- Ten-fold speed-up in turnaround time for simulation jobs.
- Much greater productivity for consultants working in design projects.



HPC Cloud-based optimisation of aircraft wiring



EXPERIMENT #408 HIGHLIGHTS

Industry Sector: **Electrical Wiring**

Country: **Netherlands**

Software used: **MORE**



ORGANIZATIONS

KEW, an SME founded in 2008, specialises in the optimisation of engineering-intensive projects in the manufacturing industry. In particular, KEW is active in the aerospace sector and has developed an application to optimise the routing of wiring within an aeroplane. This is an important issue in the design of aircraft, which traditionally has been addressed by trial and error. Although this problem can be tackled using computer models, applications to do this are very computationally intensive. SMEs generally do not have the available resources to buy and maintain the large computer systems needed to perform the necessary optimisations, nor do they have the required expertise to use such systems.

End User	Domain Expert	HPC Expert	HPC Centre
www.ke-works.com	www.noessolutions.com	www.cineca.it	www.gompute.com

THE CHALLENGE

The challenge addressed by this case study was to adapt a wiring optimisation application from KEW to run on a Cloud-based HPC system, so that wiring layouts could be optimised in a feasible length of time, at an acceptable cost. This solution would involve computationally intensive simulations that could be run on a pay-per use basis, with significant savings over owning a system, and would offer sufficient resources to satisfy demand.

THE SOLUTION

The solution has involved porting the KEW optimization software to run on an HPC system and developing the necessary "glue" software to bring all the necessary software components together taking account of any software licensing issues. The successful implementation of this solution has enabled typical optimisations to be run on an HPC system much more quickly and effectively. It should be noted that this case study was the first time that KEW had used HPC in its wiring optimization.

BUSINESS IMPACT

By using advanced simulations, KEW improved the quality of its designs, and reduced costs by 2,5% per design. Using Cloud-based HPC instead of in-house resources contributed to a reduction of 90% in the lead-time for the design of a single Electrical Wiring and Interconnection System, and an eight- to ten-fold reduction in computational costs. The impact of a single simulation may be very significant, as a single optimised wiring design may be used in hundreds of aircraft. The automated, optimised process running on a Cloud-based HPC system gave a 2,5% reduction in cost and weight of the wiring system. This is a recurring benefit, as all aircraft of the same type will utilise the same wiring design. As the aerospace industry has very fine margins, a 2,5% saving may increase profit margins by 50%. Saving one kilogram in the wiring may enable a 20kg reduction in overall aircraft weight, which will reduce fuel consumption over the aircraft's life. The cost of computation on a Cloud-based HPC system is about €660 for a single design run, compared to an annual cost of an in-house HPC system of about €61.000. Furthermore, a Cloud-based HPC system is much more flexible if more computational power is required. This demonstrates the feasibility and cost-effectiveness of using Cloud-based HPC for engineering simulations. SMEs are much more able to afford to use Cloud-based HPC, allowing them to compete better with larger organisations.

BENEFITS

- Reduction of about 90% in the lead-time for a single (non-recurring) electrical design.
- Reduction of computational costs of 8 to 10 times by using Cloud-based HPC vs in-house resources.
- Average saving of costs and weight of wiring system of 2,5%, meaning an important recurring benefit and profit margins of up to 50% in aerospace industry.





HPC Cloud-based prediction of air quality

ORGANIZATIONS

Numtech is a French SME specialised in the development and use of innovative digital tools for air-quality and meteorological simulations. They are the market leader in France for modelling the weather and atmospheric dispersion. Its customers are mainly large companies, local and regional authorities, and research institutes. Numtech makes substantial use of the ADMS code from CERC in its business. European regulations on air-quality now require more and more testing and evaluation of pollution adaptation and reduction scenarios. Rather than evaluating 2 to 3 scenarios, consulting companies and regional air-quality agencies now need to evaluate tens of scenarios. This requires an increase in their capacity for computing, beyond what they can manage with in-house resources.



End User



www.numtech.fr

Software & Domain Expertise Provider

CERC

www.cerc.co.uk

HPC Providers & Experts

Bull
atos technologies

www.bull.com

THE CHALLENGE

The challenge here was to demonstrate the use of Cloud-based-HPC services to investigate air-quality at city-scale. Running simulations using Cloud-based HPC would help to increase the numbers of scenarios which could be feasibly simulated in a given time, and reduce the computational time needed for simulations. The outcomes of using this system include shorter times for simulations and cost reductions, with resultant competitive advantages.

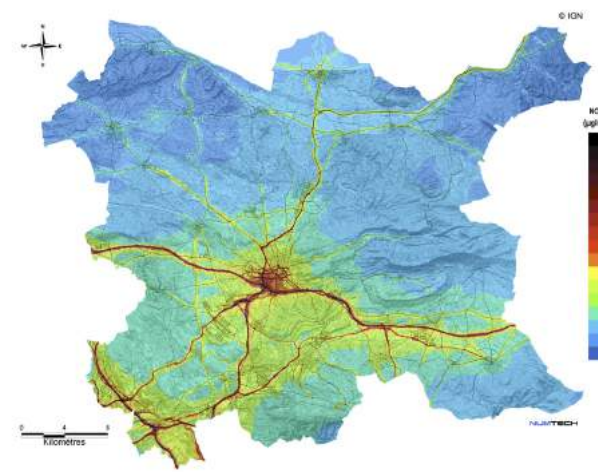

THE SOLUTION

This case study used the ADMS-Urban software from CERC running on the Extreme Factory HPC offering from BULL. ADMS-Urban was adapted to run on a Cloud-based HPC system. The results of the simulations were then made available via a familiar workstation environment. In doing this, an evaluation of the viability of this service on commercial HPC Clouds has been carried out and possible business models for such a service have been proposed.

BUSINESS IMPACT

To offer a simulation service, CERC needs to source computer cycles, which means it either needs to own and maintain a sufficiently powerful HPC system, or it needs to buy cycles from an HPC centre. In the former case, a powerful enough in-house server would need to be purchased. Investigation shows that if the average time a server is in use falls below 40%, a pay-on-demand Cloud service becomes a more economically viable option, compared with the costs to acquire and maintain that server. This depends on the mode of use, but buying cycles on demand offers considerable flexibility to SMEs looking to set up a service. As a result of this study, CERC can now offer the ADMS-Urban software as a cloud service on a pay-for-use basis, rather than requiring a customer to purchase an annual licence and run the software locally on workstations. This allows for an attractive pricing option for customers needing an infrequent use of the model. Using Cloud-based HPC services, Numtech can save production costs of €125.000 over 5 years, which allows them to offer more competitive services. By recruiting new customers, Numtech's turnover is expected to increase by a total of €750.000 over the same time. Finally, the new capacity to launch multiple scenarios at reasonable cost using SaaS constitutes a new business model that will further increase NUMTECH's turnover by €150.000 up to 2020.

EXPERIMENT #410 HIGHLIGHTS

Industry Sector:
Urban Planning
Country: **France**
Software used:
ADMS Urban

BENEFITS

- A Cloud service on a pay-for-use basis is the pricing solution for the infrequent users of HPC.
- Production savings are severely lowered in case of Cloud-based HPC services use.
- Possibility to launch multiple scenarios at a reasonable cost using SaaS constitutes a new business model that further increases the turnover.

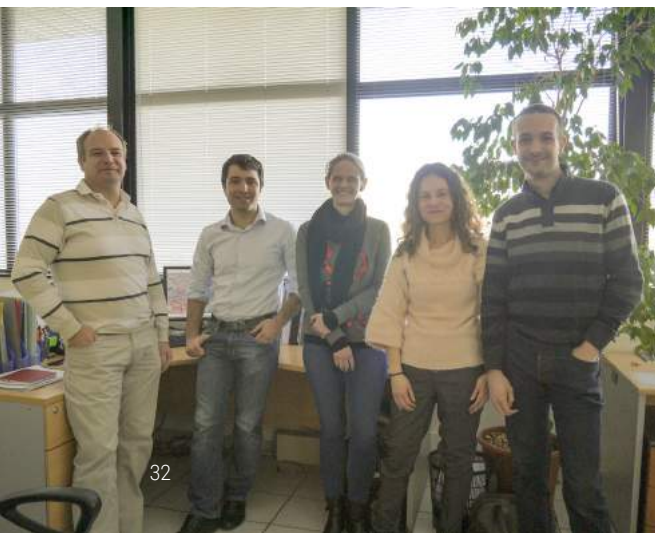



HPC Cloud-based reduction of vehicle emissions



EXPERIMENT #412 HIGHLIGHTS

Industry Sector: **Automotive**
Country: **Austria**
Software used: **AVL CRUISE**

ORGANIZATIONS

AVL is the world's largest independent company in the development of powertrain systems for internal combustion engines and associated instrumentation and test systems, and has been working in partnership with companies all over the world for more than 60 years. The need for CO2 reduction, the increasing complexity of new powertrain systems, and a requirement to achieve the highest possible level of process efficiency are some of the key challenges facing the automotive industry now and for the foreseeable future. AVL provides its customers, many of which are SMEs, with a set of comprehensive simulation tools in a flexible and open environment enabling multi-disciplinary solutions as an integral part of the powertrain development process.

End User & Code Owner

www.avl.com

HPC Centre & Expert

www.hlr.de/home/

THE CHALLENGE

This case study addresses the use of on-demand, Cloud-based HPC resources to tackle the important requirement for the reduction of CO2 emissions in the design of vehicles. The majority of projects in the area of vehicle optimization involve studies with large-scale variations in parameter and components on a limited palette of base vehicle models. These studies require high levels of CPU cycles on-demand.

THE SOLUTION

Providing sufficient computational resources to accomplish optimization tasks in an acceptable time-frame is a struggle faced not only by SMEs, but even by larger companies. The outcome of this case study has been to demonstrate the viability of on-demand computing resources in the design of powertrains with specific emphasis on the reduction of CO2 emissions. This solution involves the running of AVLs simulation codes on a Cloud-based HPC system where computer resources are made available on-demand.

BUSINESS IMPACT

The most clear cost benefit of using HPC Cloud resources is the possibility to lease a powerful computing cluster for single projects, instead of acquiring and maintaining in-house computational resources. These would likely be underutilized for most of the time, and may even not be sufficiently utilised to justify their cost when in use. Using a Cloud-based solution, taking into account all additional cloud overheads, short-term projects running millions of simulations on 400 cloud CPU cores for a period of a couple of weeks, several times a year, would run with costs reduced by up to 90% when compared to the total cost of ownership of a dedicated in-house system. This is the cost range where it becomes attractive for SMEs to participate in projects which require high CPU power for only a short time.

BENEFITS

- Possibility to lease a powerful computing cluster for single projects instead of acquiring and maintaining computational resources.
- The use of a Cloud-based solution can lead to reduced costs by up to 90%, when compared to the total cost of ownership of a dedicated in-house system.

The results of using a Cloud-based approach mean AVL are better able to offer their powerful simulation platforms to its clients. Given the breadth of the product space AVL and its clients occupy – among them diesel engines, electric drives, alternative fuels, control software, transmissions, and batteries - this should have significant economic and competitive advantages for AVL. AVL is now better able to go about its business, tackling the development of highly creative, mature and application-specific solutions for its customers in order to meet their market challenges.

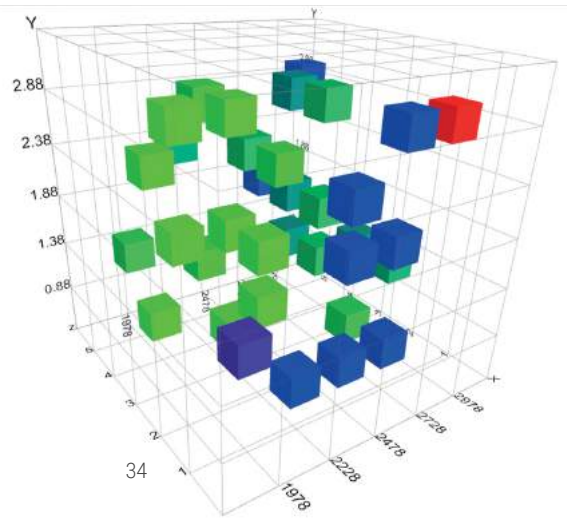

Engine Displacement (cm³)	Frontal Area (m²)	Transmission Ratio	Consumption (l/100km)
1978	1.38	1	11.04
2028	1.38	1	10.17
2078	1.38	1	12.12
2128	1.38	1	10.56
2178	1.38	1	11.17
2228	1.38	1	10.68
2278	1.38	1	10.35
2328	1.38	1	11.04
2378	1.38	1	11.06
2428	1.38	1	11.77
2478	1.38	1	11.11
2528	1.38	1	11.11
2578	1.38	1	11.02
2628	1.38	1	11.19
2678	1.38	1	11.06
2728	1.38	1	10.64
2778	1.38	1	10.7
2828	1.38	1	11.40
2878	1.38	1	11.00
2928	1.38	1	12.6
2978	1.38	1	10.64
3028	1.38	1	11.13





HPC Cloud-based simulation of hazardous chemicals

ORGANIZATIONS

Founded in 1897 in Switzerland, Lonza is one of the world's leading and most trusted suppliers to the Pharma & Biotech and Specialty Ingredients markets. A key part of Lonza's business is in distillation columns, whose operation requires a detailed knowledge of the thermodynamic properties of the target compounds. The chemical industry usually measures the required data experimentally, and this was previously how Lonza operated as well. However, when determining the properties of hazardous substances (explosive, toxic or mutagenic), computer-based simulations are a very attractive alternative to dangerous and expensive physical tests. Powerful predictive methods now exist that calculate the properties of compounds using simulation, but these require significant computing power.



End User

Lonza

www.lonza.com

Domain Expert

ThEt
UNIVERSITÄT PADERBORN
Die Universität der Informationsgesellschaft

www.uni-paderborn.de

HPC Centre & Expert

H L R I S

www.hlr.de/home

THE CHALLENGE

In this case, the goal was to demonstrate the benefits of porting an existing third-party code to an HPC system. To determine a full set of physical properties for one compound, around 200 state points need to be calculated. Currently, a single state point calculation takes 20 hours on a 16-core workstation, so the total calculation would take up to 4.000 hours - almost six months. Access to an HPC system would decrease this to a reasonable level.

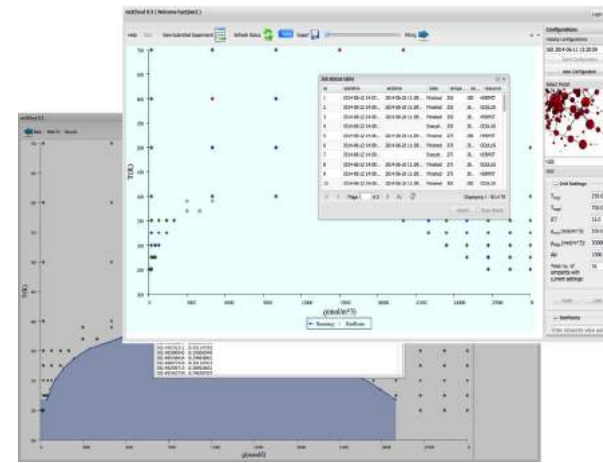
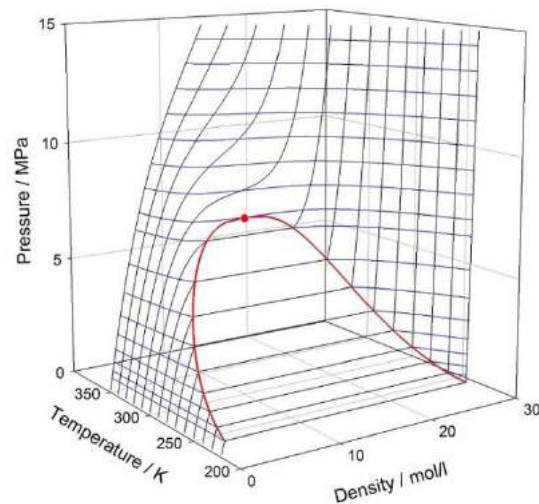
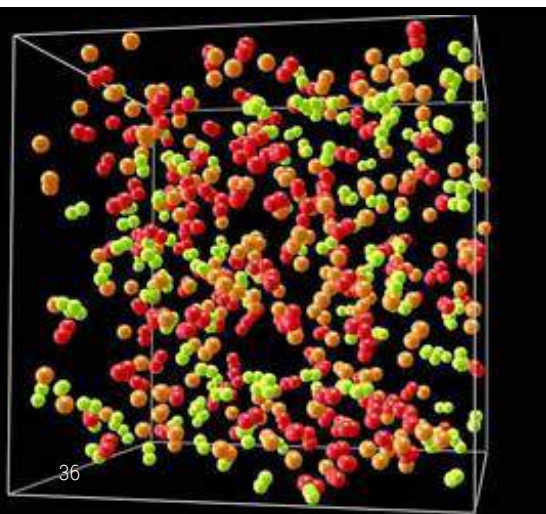

THE SOLUTION

A detailed molecular-simulation code has been implemented on an HPC system driven by a simple, web-based user interface. Multiple simulations of state points can be initiated through this interface enabling the complete thermodynamic properties of a compound to be determined in a reasonable length of time. For example, whilst the calculation of a complete set of physical properties would take ~6 months on a 16-core cluster, the calculation time can be reduced to below 20 hours on an HPC system.

BUSINESS IMPACT

The use of simulation can bring massive savings to Lonza's production process. Shortening the time needed to determine a compound's properties brings clear benefits to the design process. It is also clear that the cost of cycles is much less than that of owning and maintaining a large HPC system in-house. The cost to determine a single property of a single compound experimentally is approximately €2.700. For a mixture of compounds, this cost increases significantly - 60 gas solubility data points of a binary mixture can cost up to €50.000. Compared to that, 60 molecular simulations covering the entire fluid region up to arbitrary high pressures will cost around €1.600, while for the mixture the cost usually doubles compared to a pure component, so €3.200. Not only does this represent a huge reduction in costs for Lonza, this also covers conditions that are difficult or impossible to test experimentally. A typical distillation column designed by Lonza costs around €1,5 million. This includes the design of a system to obtain all required physical properties through experimental measurements, costing €100.000 (100 staff days at €1.000). Using a modelling simulation, this cost would be only €13.600, saving €86.400 for a single distillation process, of which Lonza designs in excess of five per year. Given these figures, it is clear that HPC cloud-based simulation has considerable benefits for Lonza.

EXPERIMENT #414 HIGHLIGHTS

Industry Sector:
Chemical Engineering

Country: **Switzerland**

Software used:
ms2

BENEFITS

- Massive savings in the production process of chemical intermediates manufacturers.
- €1.100 savings on the costs of experimentally determining pure component densities for a substance and ~€47.000 savings for mixtures of compounds.
- €86.400 overall saving in the design process of a distillation column costing €1,5 million.



HPC Cloud-based design of copper-alloy moulds



ORGANIZATIONS

Founded in 1959, IMR is an SME which designs and manufactures foundry equipment for brass alloys and bronze; the company also dedicated consulting services for designing moulds and other manufacturing processes. It is essential to ensure a laminar flow of liquid metal through the mould and a uniform cooling gradient, in order to avoid cracks and defects in the final piece. The success of this depends on the design of the mould; the quality of which usually depends on the experience of mould makers. Currently, the mould is often modified several times before committing to production. There are several commercial packages for the simulation of casting processes, but they have not been widely used in this sector.

End User



HPC Provider & Expert



THE CHALLENGE

In the past, IMR has tried to conduct simulations with commercial software, but never with HPC. The costs associated with purchasing dedicated casting software, the necessary hardware, and the training required are not viable for SMEs like IMR, whose normal activities do not require such an investment. They therefore wanted investigate how Cloud-based simulations could improve the time to market and productivity.

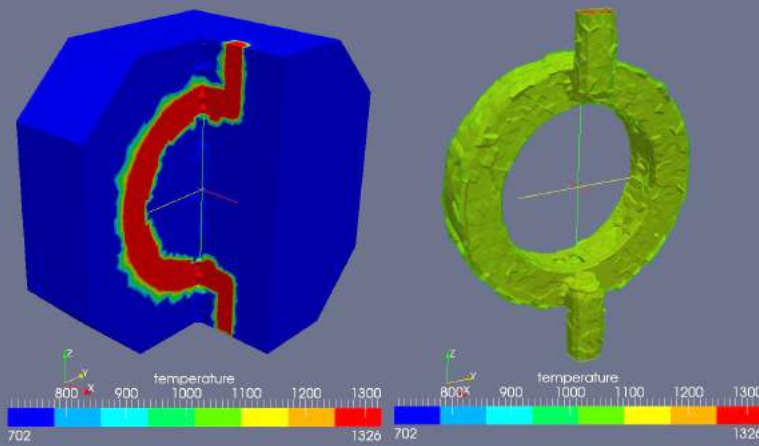
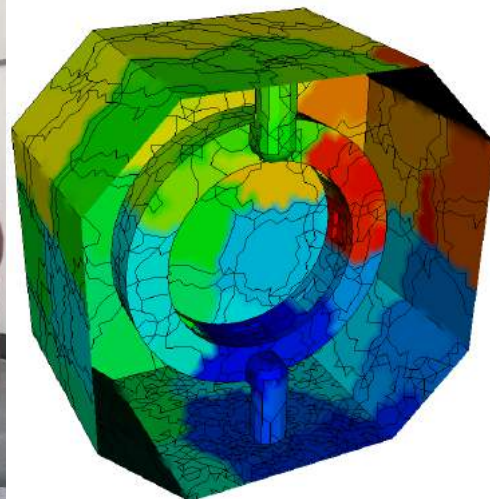

EXPERIMENT #415 HIGHLIGHTS

Industry Sector: **Casting**
Country: **Italy**
Software used: **Elmer FEM**

THE SOLUTION

A computer model was developed, based on an open-source software package, which would simulate the flow of copper alloys. This model produces a simulation of the filling of a mould by the molten copper alloy at low pressure, and the reliability of the results were validated by comparison with physical tests. Using a Cloud-based HPC system, the time for simulations could be reduced from one day to 3 hours, which is a more acceptable time frame.

BUSINESS IMPACT

Although IMR had used simulation in the past, this was their first experience of using an HPC Cloud-based system for simulations. The use of HPC reduced the number of changes required to the mould prototype during its design. This reduced by 20% the time for development of the mould and saved 20% of the cost of testing the mould before mass production can begin.

The average cost for the design and testing of a set of moulds for a new product based on the traditional, experience-based, trial-and-error method is currently about €41.000. The use of a Cloud-based HPC simulation method saves about € 8.000 per set and 3 weeks of testing and modifications. This includes all costs, such as set-up times and computing costs, not just design and testing. IMR has about 8 sets of moulds per year to develop, so this represents a total annual saving of €64.000. It also reduces the time to market of the moulds, so IMR may be able to produce more moulds per year, increasing their profitability. The ability to quickly and accurately design a mould, without the wastage of materials inherent in the trial-and-error method, will further increase their competitiveness in their business sector. Furthermore these simulations create the opportunity for IMR to offer its customers a new, HPC-based design service.

BENEFITS

- With HPC the development time is faster by 20% and with that 20% of the testing costs are saved.
- Cloud-based HPC simulation method saves about € 8.000 per set and 3 weeks of testing and modifications.
- Fast and accurate design ability without the wastage of materials inherent in the trial-and-error method amounts to annual savings of €64.000.

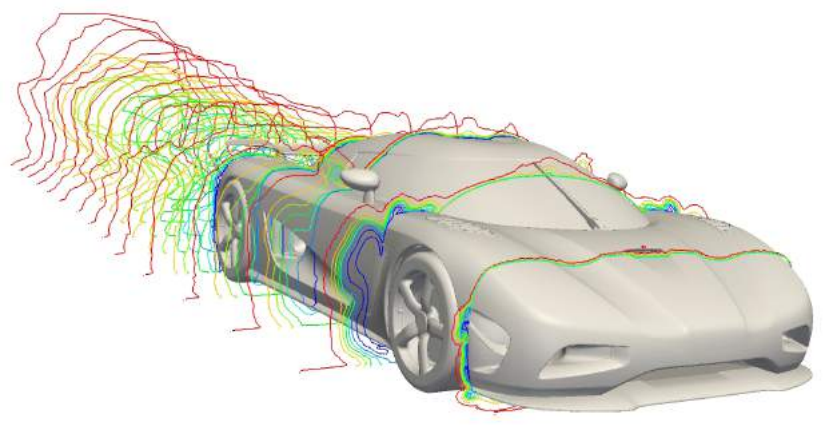

EXPERIMENT #417 HIGHLIGHTS

Industry Sector: **Automotive**

Country: **Sweden**

Software used: **iconCFD**

HPC Cloud-based simulation of sports-car aerodynamics



ORGANIZATIONS

Koenigsegg is a Swedish SME. Established in 1994, they are a leading designer and manufacturer of high-performance sports cars. In the development of these cars, intensive CFD simulations are carried out to reduce the cost of wind tunnel testing. Models are created which accurately replicate real-life cars, including all geometric details - such as rotating wheels and integrated components (including heat exchangers, fans and condensers). These models can be very large and complex, so the use of HPC can make a significant difference in how accurately a simulation can be conducted and how long it takes to complete. This case study was the first time that Koenigsegg had used HPC in the design of a hypercar, the One:1.

End User	ISV	HPC Expert	HPC Provider
www.koenigsegg.com	www.iconcf.com	www.dit.hua.gr	www.cineca.it

THE CHALLENGE

There are two ways to determine how air flows over a car: wind tunnel testing and simulating air flow using Computational Fluid Dynamics (CFD). Wind tunnel tests are expensive and time-consuming, so are only used infrequently, but simulations can be used throughout the design phase. The challenge here was to show how Cloud-based HPC resources can reduce the amount of required wind tunnel testing and show the cost-effectiveness of this approach.

THE SOLUTION

Before the start of this case study, Koenigsegg had only limited in-house computing resources and no experience in HPC-based CFD. Access to Cloud-based HPC allows simulations to run on a pay-per-use basis, which makes access to powerful computing resources financially viable for an SME, as well as reducing hardware and maintenance costs. The use of ICON simulation software on a Cloud-based HPC system has enabled Koenigsegg to reduce or even, in some circumstances, avoid wind tunnel testing.

BUSINESS IMPACT

In this case study, 100% of the aerodynamic development of the Koenigsegg One:1 has been conducted using HPC-based CFD simulations. Koenigsegg were able to completely eliminate expensive wind tunnel tests thanks to the high fidelity of HPC simulations, allowing them to have confidence that the simulation results would transfer into real-world gains. In less than eight months, hundreds of simulations to test various configurations have been carried out. The results were an impressive 250% increase in down-force with only a 15% increase in drag at 250km/h and with a 50% higher down-force at 440km/h, the vehicle's maximum speed. Tests have shown that HPC-based simulation, supported by external software and expertise, led to a return on investment in less than three months for the production of a new car configuration. Significant costs can be saved and transferred to other critical parts of the development and production process. The benefits obtainable by the use of the Fortissimo HPC-Cloud can be quantified as a 5% saving in operational costs, a 30% saving in design costs, a reduction of 50% in wind tunnel and physical testing, a 60% saving in prototyping costs, and a 30% shortening of the time to market. Furthermore, savings in development were about €90.000 per year on the design process, a 1,5% reduction in overall development costs. These calculations take account of a computing cost on the Cloud-based HPC system of around €100.000.

BENEFITS

- 5% savings in operational costs.
- 30% savings in design costs.
- 50% reduction in wind tunnel and physical testing.

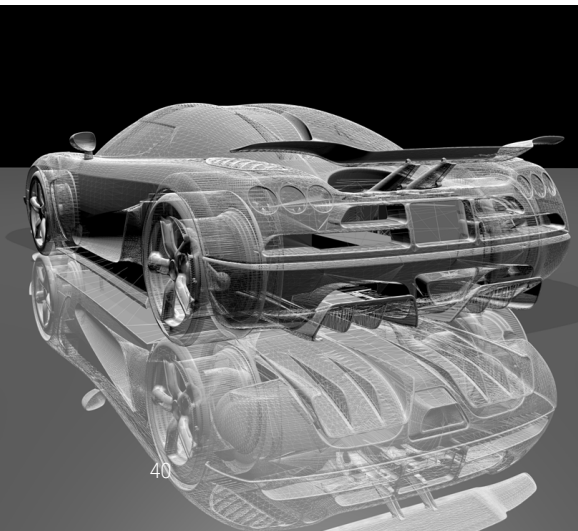



HPC Cloud-based design of centrifugal pumps

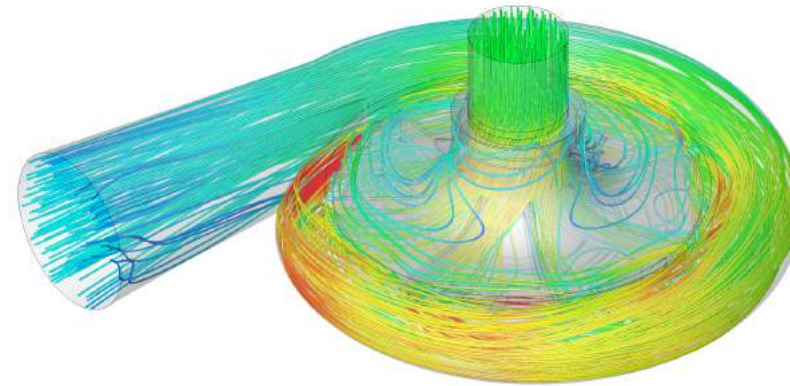

EXPERIMENT #418 HIGHLIGHTS

Industry Sector: **Turbomachinery**

Country: **Italy**

Software used: **ANSYS CFD**

ORGANIZATIONS

Founded in 1984, EnginSoft is a consulting SME operating in the field of computer-aided engineering, virtual prototyping and advanced simulation, including computational mechanics and fluid dynamics, numerical crash testing, and environmental engineering. EnginSoft has around 160 employees, 6 sites in Italy and 5 branch offices in Europe. In this case study, Enginsoft addressed the design of centrifugal pumps using advanced HPC-based simulation. Centrifugal pumps are widely used in many industrial applications, from oil & gas to water treatment, automotive and home appliances. Such devices may be required to operate over a wide flow range and the prediction of operating characteristic curves is essential for a designer.

End User



www.enginsoft.com

Computer Centre & HPC Expert



www.cineca.it

THE CHALLENGE

Numerical simulation has become an important and common tool for pump designers. Many tasks can be solved faster and cheaper numerically than by means of experiments and, most important, the complex internal flows in water pump impellers can be predicted well. Performing the numerical simulations required would not be possible for a typical SME, which has neither the technical expertise nor the computing resources to carry out such a simulation.

THE SOLUTION

A simulation model has been implemented on a Cloud-based HPC system for a centrifugal pump using a commercially available software package. This represents an attractive solution in terms of cost, effectiveness and relevance for those SMEs which do not have the resources to perform the necessary simulations on their own. The benefits of simulation using Cloud-based HPC system has been demonstrated through a series of experimental runs.

BUSINESS IMPACT

The test runs have shown that the use of HPC-based simulation using a combination of Cloud infrastructure and external expertise results in a return on investment in less than six months. The simulation of centrifugal pumps is not easy due to a number of challenges: complex geometries, unsteady flows, turbulence, secondary flows, flow separation, boundary layers and so on. Simulating these requires a high-fidelity CFD model, very fine computational grids and the analysis of transient flows. The design and optimisation of a single pump can thus take 2 to 3 years to complete. With the dvantage of access to Cloud-based HPC, this can be reduced to 6 months. The improved design process using simulations can give Enginsoft a significant commercial advantage, allowing them to design and test up to six different pump designs in the time it would take a competitor to perfect a single design. It can also offer these pumps at an extremely competitive cost thanks to the money saved: not only do EnginSoft not need to purchase and maintain costly dedicated computational resources, the increased efficiency of HPC-based simulations saves time, and therefore money, throughout the design process. Due to this improvement in the design process, Enginsoft expects to increase its market share by at least 1% with a resultant profit of €100.000 per year.

BENEFITS

- Timeframe for a new hydro plant reduced from 2-3 years to 6 months.
- Customized workflow for pump design optimization.
- Increase of market share by 1% with resultant profit of €100.000.

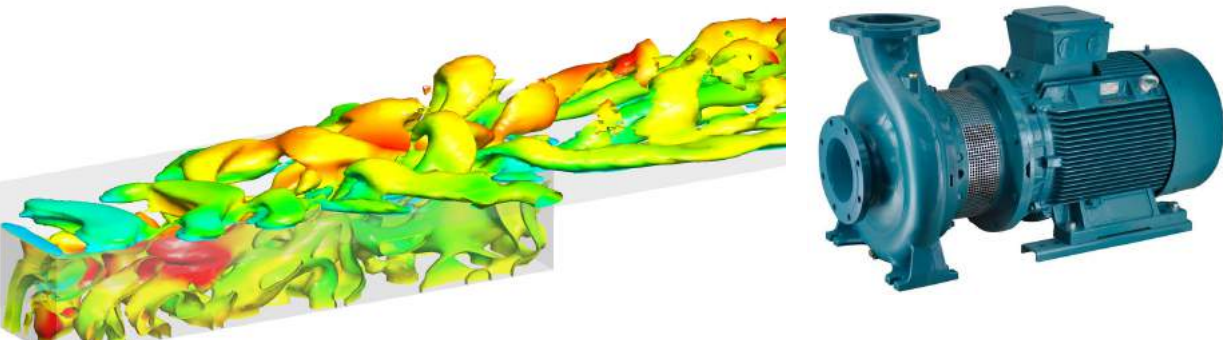
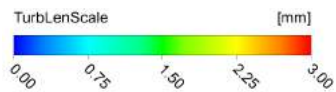



HPC Cloud-based simulation of drifting snow

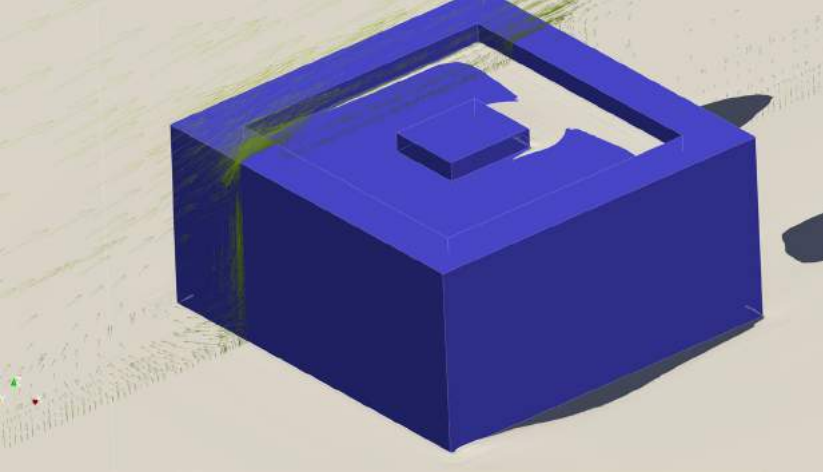

EXPERIMENT #419 HIGHLIGHTS

Industry Sector: **Civil Engineering**

Country: **Canada**

Software used: **OpenFOAM**

ORGANIZATIONS

Founded in 2005, Binkz is an SME whose business is consultancy, specialising in single and multiphase flows. Binkz provides state-of-the-art consultancy services using Computational Fluid Dynamics (CFD) for applications such as wind engineering, process technology and aircraft icing. Binkz has developed the CFD program snowFoam. This program allows an accurate assessment of snow loads on buildings. The maximum snow load that may be accumulated on a building rooftop is an essential parameter in assessing the safety and stability of a building. When compared to existing alternatives, snowFoam is more accurate, more reliable and more versatile, but it requires the computational resources that only an HPC system can provide.

End User & Code Developer

BinkZ Inc.

www.binkz.ca

HPC Expert



www.vortech.nl

HPC Provider



www.surfsara.nl

THE CHALLENGE

The overall challenge was to study the commercial feasibility of a CFD consultation service for assessing snow loads on buildings, employing snowFoam, to civil engineering firms on the Fortissimo HPC Cloud infrastructure. For the viability of such a consultancy service, it is essential that both the simulation time and the cost of the computation are acceptable within the framework of a typical CFD consultation project.

THE SOLUTION

This case study has shown that the simulation of drifting snow using snowFoam is feasible using a Cloud-based HPC system. Analysis can be completed within a few weeks, which fits well with the timescales for the design of buildings. In the solution developed here, the user has access to computing resources, storage, and visualization facilities from a desktop environment. The required computational resources needed and their costs are appropriate considering those for the overall design of a building.

BUSINESS IMPACT

Every year, roof collapses due to accumulated and drifting snow are responsible for losses of hundreds of millions of Euros as well as bodily injuries and loss of life. This is a problem for all countries in Northern Europe and more generally in the Northern hemisphere. The maximum snow load that may be accumulated on a building rooftop is an essential parameter in assessing the safety and stability of a building. It is, however, hard to predict the maximum snow load when designing a new building. This leads to a costly over-design of the structure, which could be avoided if the snow load could be predicted with sufficient accuracy. The simulation of drifting snow requires significant compute resources, which can only be provided by a large HPC system. A typical simulation of drifting snow takes 50.000 CPU hours. This equates to 150 CPUs for 14 days. Furthermore, at a cost of €0,2 per CPU hour, this represents a cost of €10.000. A small consultancy at Binkz would not be able to afford the capital cost of a system containing 150 CPUs, neither could it use a smaller system in-house because the computation time would be much longer than the target two weeks. Even if Binkz were to buy a suitable system, then it would only be used for a fraction of the time and its overall costs would be much greater than the use of a Cloud-based system. Consequently, there is a clear benefit for Binkz in the use of a Cloud-based HPC system.

BENEFITS

- The simulation of drifting snow requires significant compute resources, which can only be provided by a large HPC system.

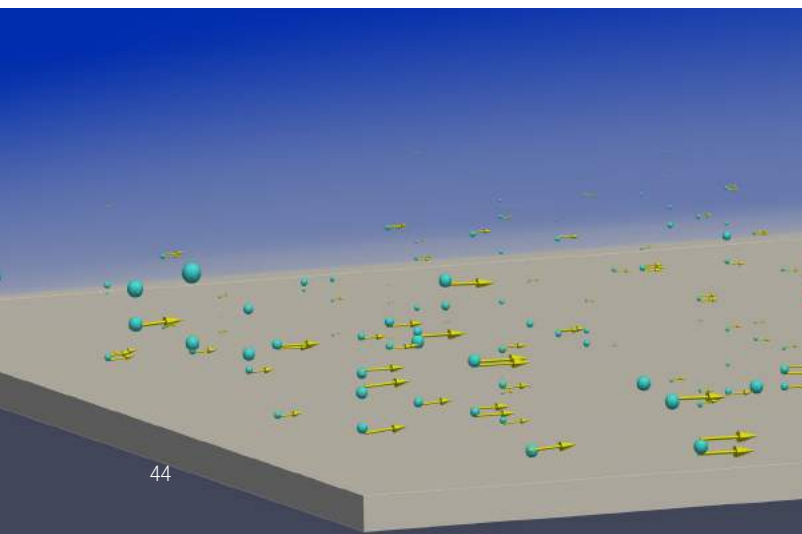



HPC Cloud-based molecular modelling

ORGANIZATIONS

The Albemarle Corporation is a global leader in the development, manufacture, and distribution of highly engineered speciality chemicals. It serves customers in approximately 100 countries in a wide range of sectors, including petroleum refining, automotive, transportation, pharmaceuticals, and food safety. Albemarle already uses HPC in the development of its products, however, it wants to improve its capability in this area through the use of CPU-GPU hybrid HPC platforms which offer significant benefits in terms of price-performance and power-performance. In order to take advantage of this, the simulation codes in use by Albemarle need some reprogramming.



End User



ISV



HPC Expert & Service Provider



THE CHALLENGE

The challenge in this case was to port an existing simulation code for molecular modelling so that it would run on a hybrid HPC platform. To demonstrate the successful porting of this code and the benefits of using a hybrid HPC system, a test case was chosen from the petroleum refining sector which involved the use of catalysts in the removal of sulphur from vehicle fuels.

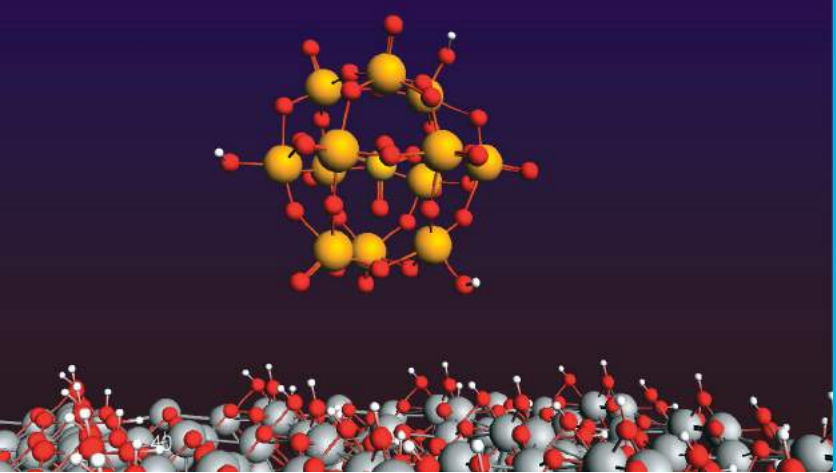
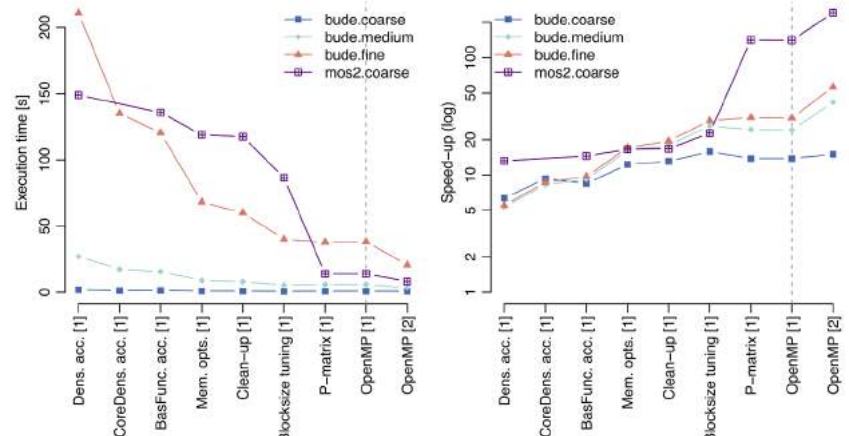
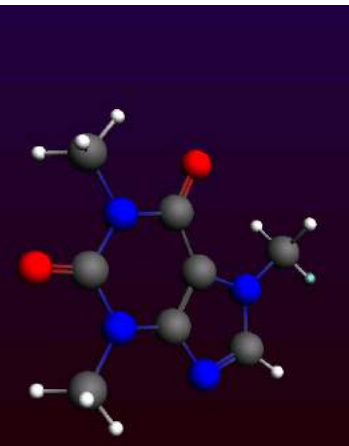

EXPERIMENT #420 HIGHLIGHTS

Industry Sector: **Chemical Engineering**
Country: **Netherlands**
Software used: **ReaxFF**

THE SOLUTION

Molecular modelling is a proven powerful tool, providing key information for the design of new chemicals and materials. However, accurate molecular modelling requires significant computing power that even an SME with experience in HPC, such as Albemarle, would not have access to. The solution involved not only the porting of the simulation code for the target computer system, but also the development of a simple user interface to prepare the models and their submission to the HPC system.

BUSINESS IMPACT

The software for modelling large-scale molecular systems has applications in sectors such as electronics, organic chemistry, food, paints, dyes, adhesives and alloys and ceramics for the aerospace industry. Modelling these systems is complex, and in this case required the use of a CPU-GPU hybrid system to provide the necessary computational power. This case study demonstrated a successful port of a molecular modelling software package to a hybrid HPC system, with resultant cost benefits. It was determined that, in this case, the annual costs for the use of a Cloud-based HPC system on a pay-per-use basis were approximately half that of owning and maintaining a sufficiently powerful in-house system, representing a yearly saving of €38.000. The ability to access powerful computing resources on a pay-per-use basis offers significant flexibility to SMEs who would not be able to access HPC in other ways. This allows them to develop and refine their product lines more efficiently, giving them a competitive advantage in their sectors. The results of this case study will benefit many SMEs, not just Albemarle, as the code developed in this case study can be offered to other companies wishing to perform detailed molecular simulations. As a result of this case study, Albemarle has allocated a significant budget for Cloud-based HPC computing for its next business year.

BENEFITS

- The use of a Cloud-based HPC system on a pay-per-use basis is up to 50% cheaper than owning and maintaining a sufficiently powerful in-house system, representing a yearly saving of €38.000.
- Albemarle has allocated a significant budget for Cloud-based HPC computing for its next business year.



EXPERIMENT #501 HIGHLIGHTS

Industry Sector:
Renewable Energies
Country: **Spain**
Software used:
In house code

Cloud-based map interpolation for civil engineering



ORGANIZATIONS

Sisener Ingenieros, a Spanish SME, is an engineering company whose main market is in energy projects, especially in the field of renewables. Projects undertaken by Sisener need accurate topographical information not only to determine the earthworks to be performed (which depends on intrinsic information, such as levels, slopes and volumes) but also for the overall design of the installation. Ingeniería y Control Electrónico (Ingecon), a Spanish SME, develops and sells software for managing cartographic data. The objective of this experiment is to demonstrate how Cloud-based HPC can be used to convert and manage cartographic data across a range of formats and resolutions in order to improve the design process of wind farms and to reduce overall costs.

End User



www.sisener.com

HPC Expert



www.ingenieriycontrol.es

HPC Provider



www.cesga.es

THE CHALLENGE

Civil engineering projects need accurate cartographic data, requiring a map resolution of 1 metre or finer. Maps at this resolution are often unavailable, but can be created by applying a Kriging interpolation to existing maps. However, this is numerically intensive and typically requires HPC resources which are unavailable to SMEs. The challenge here was to create a solution using Ingecon's existing software that would be viable for Sisener.

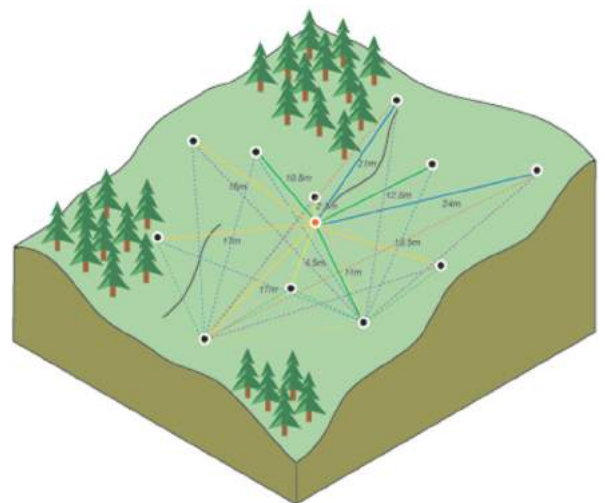
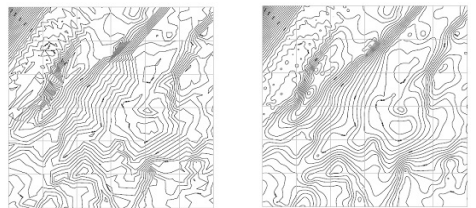
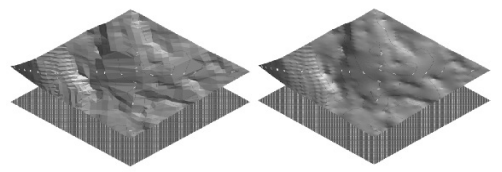

THE SOLUTION

Ingecon has ported its software to run on an HPC system via a PC-based GUI. The use of HPC has reduced the processing times for wind farms to a few minutes and for other projects requiring greater resolution to a few hours. For the software vendor this is a scalable way to offer a new service to customers. Civil engineering companies save time and money because data acquisition times are reduced and expensive data gathering can be replaced by cheaper, quicker numerical interpolation.

BUSINESS IMPACT

Ingecon sees this as a major opportunity to provide a new service not only in the design of wind farms, but also in other application areas where cartographic data is used. For a company like Sisener, the costs of a yearly software licence and a powerful enough computer to perform the necessary computations are prohibitive. However, a pay-per-use service where computing costs and software licensing are available, would be a very attractive proposition for all parties.

The major benefit for Sisener is a reduction in the cost of map data. Through the use of interpolation, as opposed to buying raw data, the cost of a typical design can be reduced from €4.000 to €2.000 taking staff effort and computing costs into account. A company like Sisener will be involved in around 25 such projects per year, so annual savings amount to €50.000.

Ingecon already has two further companies testing this solution and expects to engage 10 companies by the end of 2016. Based on data from Eurostat, there are over 350.000 potential customers across the EU for the proposed service from Ingecon of which 40.000 are based in Spain. Ingecon estimates a yearly income from this service at €200 per customer with 200 customers by 2018 and a 1% share of the European market (3.500 customers and a revenue of €700.000) by 2020.

BENEFITS

- Reduction in the cost of map data.
- Cost of typical design can be reduced from €4.000 to €2.000 taking in account staff effort and computing costs.
- Annual savings up to €50.000.
- New potential customers for HPC Expert from this new service.



Advanced simulation of electromagnetic effects



EXPERIMENT #502 HIGHLIGHTS
Industry Sector: **Electrical Engineering**
Country: **France**
Software used: **Gramat**

ORGANIZATIONS

SEEMI is a French SME which develops solutions for product packaging and transport. The devices it builds are often found in environments with significant electromagnetic fields, which can lead to serious malfunctions in equipment. Electrical devices play a major role in all types of automated and embedded systems. Cables, both shielded and non-shielded, have become a major issue in terms of safety, weight, performance, power consumption, cost and reliability. It is essential to verify during the design stage that cables are not susceptible to external electromagnetic effects, and to shield from any potential interference. Simulation has become mandatory in making such decisions. The customers for products designed by SEEMI are major national and international groups.

End User	HPC Expert	ISV	HPC Provider
www.seemi.com	www.inria.fr	www.algotech-informatique.com	www.bull.com

THE CHALLENGE

AlgoTech has developed an electromagnetic simulator running on a PC to simulate small and medium-sized problems for customers. This approach allows SMEs, such as SEEMI, to reduce the design time and costs of electrical networks used in the packaging and other sectors. For larger installations, computing on a PC becomes too time-consuming to meet user requirements, as thousands of calculations are needed to cover a range of common frequencies.

THE SOLUTION

The solution developed here provides seamless access to their code, running on an HPC machine, from a PC. Cloud-based HPC has dramatically reduced the computation time for complex electromagnetic simulations from hours to seconds, and is now an essential tool for simulating the complex electromagnetic behaviour of equipment. AlgoTech now offers a pay-per-use electromagnetic-design service to its customers which enables them to carry out large-scale simulations as needed.

BUSINESS IMPACT

The cost-benefits of simulating the electromagnetic behaviour of devices depends on where they are deployed. For example, an electromagnetic issue in manufacturing equipment has cost implications, but may present no danger to life. In contrast, unwanted electromagnetic effects in a vehicle may constitute a significant danger. In the former case, the value of a simulation can be estimated at 1% of the cost of the risk. In the latter case, the value of a simulation can be much greater because the cost of the risk is much higher. The market price for a small-scale simulation of the electromagnetic behaviour of a device is around €240. This cost can be broken down as follows: €200 for AlgoTech to cover licence fees; and €40 to the computer centre for the cost of cycles. For a larger simulation the market price is €1.750: €1.500 in licence fees; and €250 for the cost of cycles.

For the end users, the cost of electromagnetic issues, detected during the installation phase on customer premises, would be between tens to hundreds of thousands €. This compares favourably with the corresponding costs and benefits of simulation. As a result of the new service it can offer, AlgoTech expects to see an increase of 10% in licence revenue and for HPC-based simulations to constitute 20% of its overall business. Overall, it expects an annual growth in its revenue of around 8% as a result of its new HPC-based, electromagnetic-simulation.

BENEFITS

- For the end users, the cost of electromagnetic issues reduces from hundreds to tens of thousands €.
- Due to the new service offered an increase of 10% in licence revenue is expected in AlgoTech.
- Due to the new HPC-based simulations an annual growth in revenue of around 8% is expected.

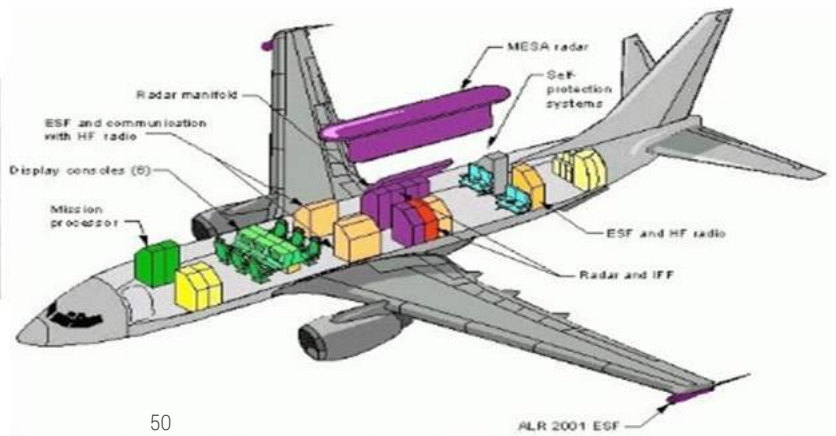



Advanced simulation of metal casting

ORGANIZATIONS

Fundiciones de Roda is a Spanish SME specialising in the casting of grey and ductile cast iron. To save time and money, foundries need advanced simulation to detect metal casting defects as soon as possible, but, like many other SMEs in this sector, Fundiciones de Roda finds the advanced simulation of its casting process prohibitively expensive because of the costs of software licences and of computer hardware. Quantech is an ISV which develops and markets the software package Click2Cast, which simulates the casting of a range of metals including aluminium, steel, brass and copper. The software is able to simulate a range of components such as automobile and aerospace components, hydraulic valves, turbine disks, impellers and flanges.

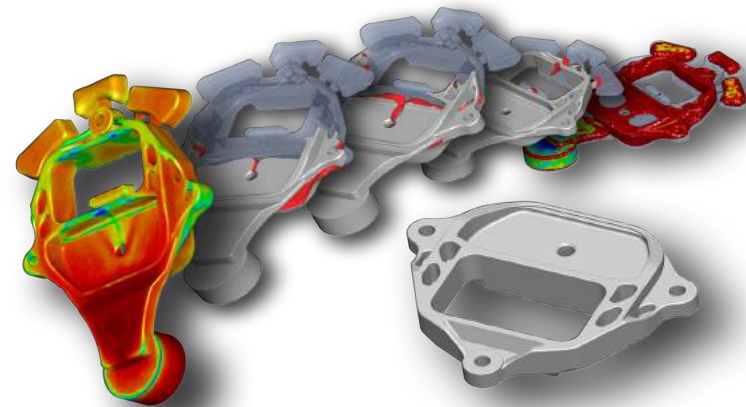

EXPERIMENT #503 HIGHLIGHTS

Industry Sector: **Casting**
 Country: **Spain**
 Software used: **Click2Cast**

End User



www.fundicionesderoda.es

HPC Expert



www.cimne.com

ISV



www.quantech.es

HPC Provider



www.cesga.es

THE CHALLENGE

Many SMEs in the casting industry are reluctant to use advanced simulation software because of the high costs of software licences and of access High Performance hardware. Here, a service was developed based on Quantech's Click2Cast package which offers SMEs such as Fundiciones de Roda an affordable, pay-per-use option for simulating casting processes accurately and quickly and without the need for detailed specialist knowledge.

THE SOLUTION

Click2Cast has been ported to a High Performance Computer system available via a Cloud infrastructure. Access to this application has been made available as a pay-per-use service which enables even inexperienced users access to advanced simulation via a simple click-based interface. Click2Cast tackles 90% of all casting techniques including High Pressure Die Casting, Gravity Casting, Low pressure Die Casting and Tilt Pouring.

BUSINESS IMPACT

The use of Click2Cast simulation service supported by an HPC Cloud enables a foundry to determine the most efficient casting technique quickly and optimise its configuration. In this way, the weight of casting systems can be reduced as much as possible. In particular, the use of a service that simulates the completed metal casting processes can significantly save time and money in the development of new types of moulds, because defects in the casting process can be detected at design time and before expensive prototyping.

A pay-per-use service such as that now offered is a very attractive option for SMEs in this sector. Through the use of an HPC Cloud-based service, design times can be significantly reduced by up to 60% - from a week to a couple of days. Through the use of the Click2Cast service Fundiciones de Roda can reduce its annual design costs by €3.200. Furthermore, because of an increase in productivity, it expects to increase its annual revenue by €20.000.

Quantech now offers the only casting design and simulation pay-per-use service in the market. Over the next 5 years, the growth in its business is estimated to be 40%, with a total of approximately 500 new customers by the third year. The additional profit for Quantech per customer is estimated to be €1.000 per annum.

BENEFITS

- Design time can be reduced by up to 60% - from a week to a couple of days.
- Reduction of end user's annual design costs by €3.200.
- Increased annual revenue by €20.000 as a result of increased in productivity.
- New potential customers and the business growth estimated up to 40%.





Simulation of airflow in concentric chimneys

ORGANIZATIONS

DINAK is a Spanish SME that specialises in designing, manufacturing and installing domestic and industrial chimneys and ventilation systems. In order to improve its capabilities and be competitive in a global market, DINAK needs to optimize its chimney designs to reduce CO2 emissions and be more energy efficient. The design process involves many variables, so physical testing is not feasible on the grounds of cost and time. DINAK thus needs a simple and powerful tool to analyse and test the design of exhaust chimneys, help them to improve the design of concentric chimneys, and gain understanding of the exhaust processes. To reduce design times to reasonable levels, HPC has become an essential component in the development of such a design tool.



End User



www.dinak.com

HPC Expert



www.gac.udc.es

Application Expert



www.aimen.es

HPC Provider



www.cesga.es

THE CHALLENGE

In a building with stoves, chimneys need to be installed to ensure proper ventilation, and poorly designed chimneys can cause incomplete combustion. Reducing emissions requires designing new, optimised chimneys, and simulation plays an important role in the design process. There are many complex variables involved in the optimization of the design of a chimney, and physical tests are generally too expensive and time-consuming to conduct.

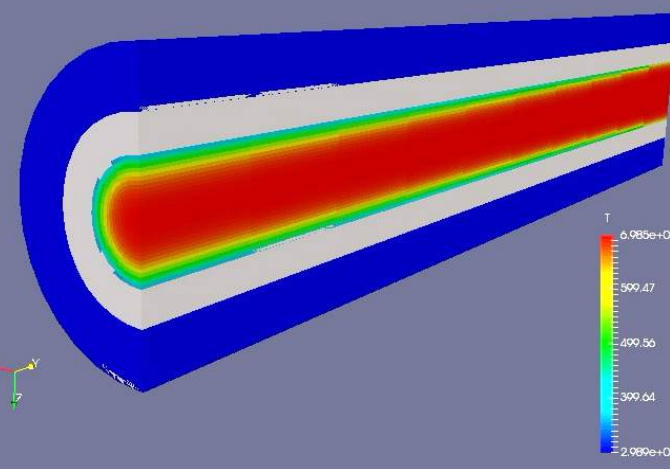

EXPERIMENT #505 HIGHLIGHTS

Industry Sector: Energy
Country: Spain
Software used: OpenFOAM

THE SOLUTION

A reliable HPC-based simulation, based around the open-source Open Foam package, was implemented to allow DINAK to shorten the design process down to a single week. A user interface provides the ability to explore the design space in a systematic way, improving the quality of the resulting designs. This experiment, successfully validated against commercial software and experimental data, has demonstrated that the design of concentric chimneys using HPC-based simulation resources is feasible and accurate.

BUSINESS IMPACT

HPC simulation has enabled DINAK to accelerate and optimise the design of concentric chimneys, allowing them to increase their competitiveness and enter new markets. In the past, the first company to market with a new chimney design could expect to increase their market share by up to 10%. Currently, DINAK develops around 3 to 4 new products per year, and this advantage would increase its turnover by approximately €100.000. Before this experiment, DINAK required approximately a month for the design and testing of a new chimney. The cost of a single chimney design was €13.400 - 3 specialist engineers for 1 month (€9.300), 1 craftsman for 1 month (€2.100) and prototype costs of €2.000. HPC simulation reduced this time to 1 week, and costs reduce to €1.140 - 1 week of an engineer's time (€900) and computing costs of €240. This gives DINAK a saving of over €12.250 per design, and the optimised design enables DINAK products to pass CE Mark tests with a zero failure rate. Previously there were 1 to 2 failures per year resulting in additional operating costs of around €6.000. Based on experience gained in this experiment, UDC is planning to offer, via the Fortissimo Marketplace, a consultancy service to develop web interfaces for Cloud-based applications. AIMEN will be able to offer consultancy services in the Marketplace based on OpenSource modelling. CESGA will increase its sales of computer cycles by around 10.000 CPU hours per year.

BENEFITS

- HPC simulation reduced design and testing costs, which resulted in savings over €12.250 for end user.
- Optimized design enables DINAK products to pass CE Mark tests with a zero-failure rate.
- Potentialities to increase sales of computer cycles by around 10.000 CPU h/year for CESGA.



High-Performance gear analyzer

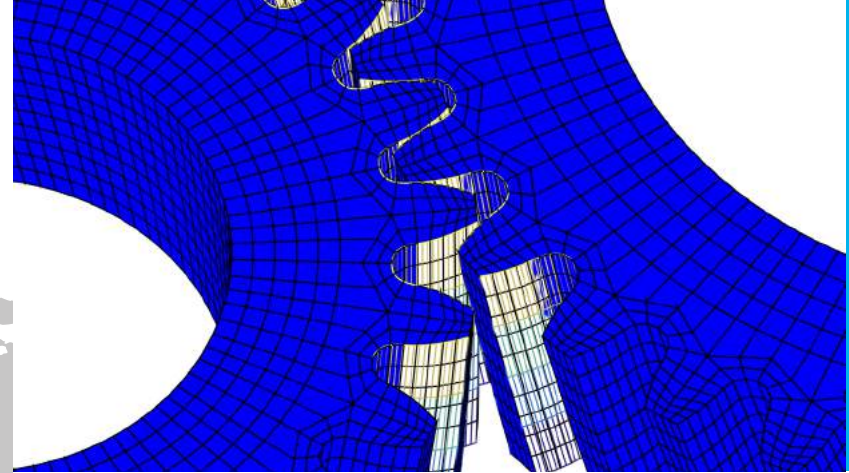

EXPERIMENT #506 HIGHLIGHTS
Industry Sector: **Automotive**
Country: **Italy**
Software used: **MSC Marc**



ORGANIZATIONS

VE&D is an SME which has been working in the field of automotive engineering for over 50 years, providing design services to its industrial partners. In particular, it has been involved in designing gearboxes for large companies such as Piaggio. Italy has a large number of gear manufacturers, many of whom are SMEs, operating in the areas of gear production, gear design and gearbox manufacture. The objective of this experiment was to develop an HPC Cloud-based High Performance Gear Analyzer (HPGA) using advanced software and High Performance Computing resources which would allow SMEs such as VE&D to benefit from the most advanced methods for gear analysis and design.

End User



www.veandd.eu

HPC Expert & Provider



www.cineca.it

Application Expert & ISV



www.unimore.it

THE CHALLENGE

A typical SME gear designer is generally an expert in gears and traditional design tools. They usually have only a basic knowledge of software for structural analysis, and limited awareness of specialized applications. The challenge here was to support the design of reliable and efficient gears using Cloud-based advanced simulation, without the need for significant investments in computational resources, expensive software licences and training.

THE SOLUTION

The research group of UNIMORE, the ISV partner in this experiment, developed several computational tools for gear analysis and optimization. It became clear that HPC Cloud technologies would be needed to create a tool for design engineers with an appropriate time to solution. The HPGA software appears as a simple user interface with standard gear datasheets, menus for the creation of gear geometry and checking for data coherence, performance analysis and optimization, and the presentation of results.

BUSINESS IMPACT

The current yearly costs for VE&D to simulate gears in-house are approximately €160.000: €10.000 for software licences; €88.000 for staff costs, computer hardware costs of between €20.000 to €40.000 and other costs (administration, personnel and security) of €32.000. The yearly costs for VE&D to simulate gears using HPGA via Cloud-based HPC are approximately €143.000: €10.000 for the use of HPGA (licence and computing costs included); €25.000 for computer hardware, €79.000 for staff costs and other costs of €28.000. VE&D will see an annual saving of €17.000 as a result of using HPGA via Cloud-based HPC. Given that there are a significant number of SMEs, which design gears, this represents a substantial saving across this sector. A further benefit is that HPGA enables tooth contact analysis, which is more refined than that currently performed by VE&D. The market is going to increasingly require this kind of analysis. Having this capability is expected to increase VE&D's market share. For the ISV UNIMORE the benefits of HPGA will be twofold. Firstly, there will be a direct increase of contracts related to the design of mechanical transmissions, starting from the actual turnover of about €20.000 per annum in 2017 rising to €100.000 per annum after 5 years. Secondly, the reputation of UNIMORE will rise leading to a subsequent increase in collaborative research projects.

BENEFITS

- Annual savings of €17.000 for end user VE&D as a result of using HPGA via Cloud-based HPC.
- Increased market share.
- Increased reputation.





Simulation of laser-based welding in the automobile and machine tool sectors

ORGANIZATIONS

Lasersystemtechnik Bollinger & Ohr (LBO) is an SME founded in 1999, specialising in laser-welding technology. Many of the components of automobiles and machine tools are welded, and these welds can suffer thermally-induced stress during manufacture. This can result in flaws which may affect the durability of components. Traditionally, testing of welds involves the cutting, polishing and sanding of samples to obtain micro-sections, but this is expensive and destroys the piece being inspected. Simulation of the welding process on an HPC system would dramatically reduce the time to assess and optimise a particular weld, thus avoiding expensive prototypes.



End User



www.lasersystemtechnik.de

HPC & Application Expert, ISV



www.lauer-weiss.de

HPC Provider, Expert & Host Centre



www.hlrs.de

THE CHALLENGE

Simulations allow companies avoid costly physical prototypes and the speed-up of the development cycle. However, there are few, if any, simulation tools to model welding processes, because they are highly complex and difficult to observe. Accurate simulations require significant computing power due to the non-linear behaviour of materials and the highly transient conditions, and SMEs cannot afford the necessary computer hardware.

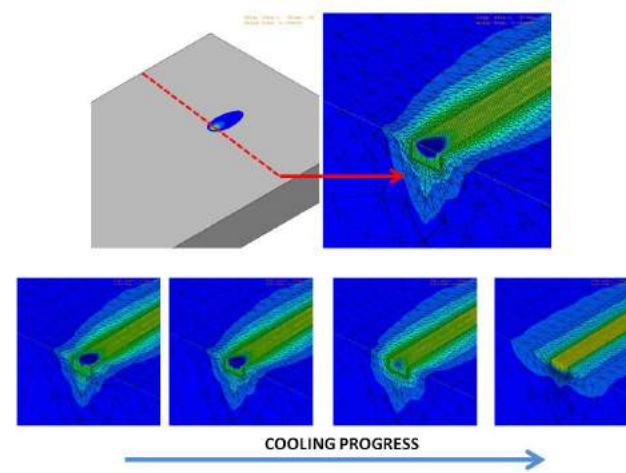
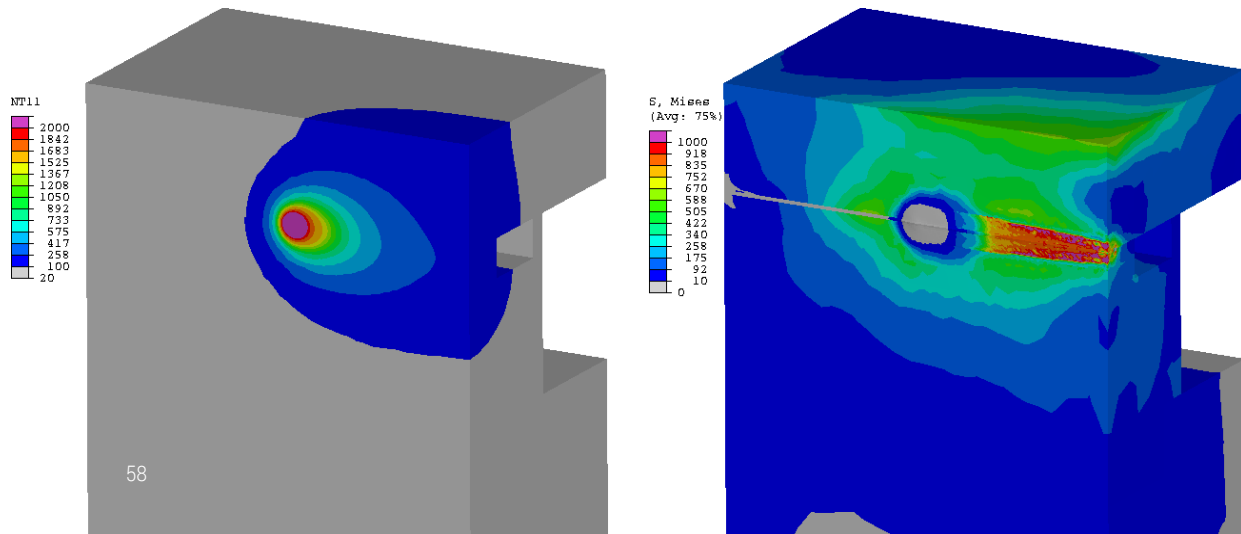

THE SOLUTION

Lauer & Weiss (L&W), an expert in the development of software solutions for the automobile and machine tool industry, has developed a simulation of laser-welding processes based on the commercially available ABAQUS package. The accuracy of this methodology has been positively assessed through the physical inspection of welding samples in cooperation with LBO. This confirms that simulated welds accurately model real-world cases and that expensive physical prototypes can be eliminated.

BUSINESS IMPACT

The cost of a physical prototype at LBO is approximately €3.300, and testing takes around one week. In physical prototyping, multiple trials are usually needed, costing in total €13.000 and 3 weeks of time. In comparison, a computer-based analysis costs L&W €6.000. Results are available within two weeks. Once a running FEM model has been created, modifications to certain parameters are made very quickly, thus a second simulation loop is less expensive. The in-house cycle and licence fees remains at €2.000, but the staff cost reduces to ~€500. Assuming that three simulations runs are necessary to find suitable welding parameters, the costs for the evaluation of a weld at L&W using HPC-based simulation are about €11.000, which is almost the same as the physical weld trials at LBO with roughly the same development time. However, a complex calculation of a welding process would block all licences at L&W for seven days. This means that no other projects could be processed during this time, which is not acceptable. In recent years, LBO has conducted four to five expensive welding trials per year. Using Cloud-based HPC simulations, L&W can generate a significant cost reduction of ~€40.000 per year for these trials. For each new client like LBO, L&W sees a further benefit of €20.000 to €30.000. In Germany alone there are several tens of such companies which gives L&W a significant potential for new business.

EXPERIMENT #507 HIGHLIGHTS

Industry Sector:
Laser Welding
Country: **Germany**
Software used:
Abaqus

BENEFITS

- Reduced computing time to less than 24 hours for L&W, through the use of HPC Cloud resources.
- The costs for an HPC-based evaluation can be reduced to about €5.500.
- Cost reduction of ~€40.000 per year for L&W's welding trials, through the use of Cloud-based HPC simulations.



Cloud-based simulation of target drug compounds



ORGANIZATIONS

Transinsight is a German SME which develops software products in the area of bioinformatics where it analyses high-throughput data. This case study addresses the identification of existing drugs to treat illnesses other than those for which they are currently prescribed. This has the potential to make a significant impact in drug discovery where the costs of developing new treatments are becoming prohibitive. The assessment of target compounds requires the use of Cloud-based HPC because the search space is so large and complex. A new Cloud-based HPC service will be offered by Transinsight to support drug discovery both by SMEs and by larger organisations.



THE CHALLENGE

In the field of drug discovery, there is great interest in investigating unknown drug-target relationships of existing compounds. Investigating these requires significant computational resources. The use of Cloud-based computing can speed up drug development and reduce its costs by uncovering off-target effects, and thus causes of adverse drug reactions, early in the development pipeline.

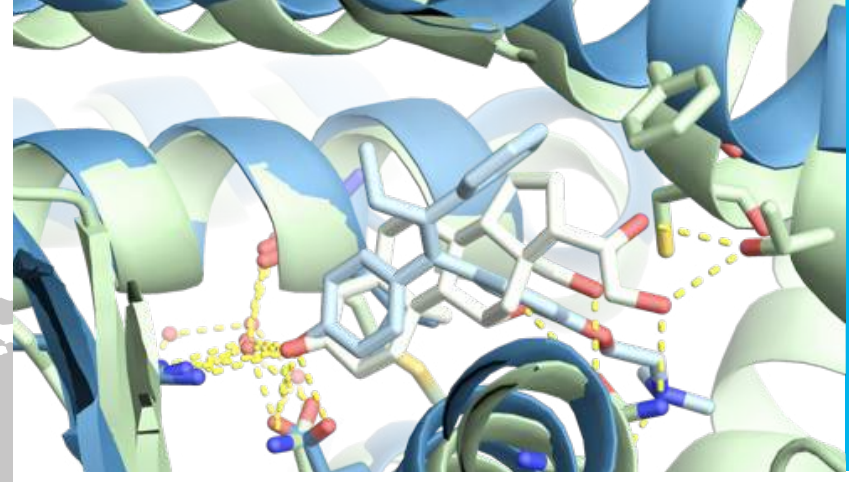
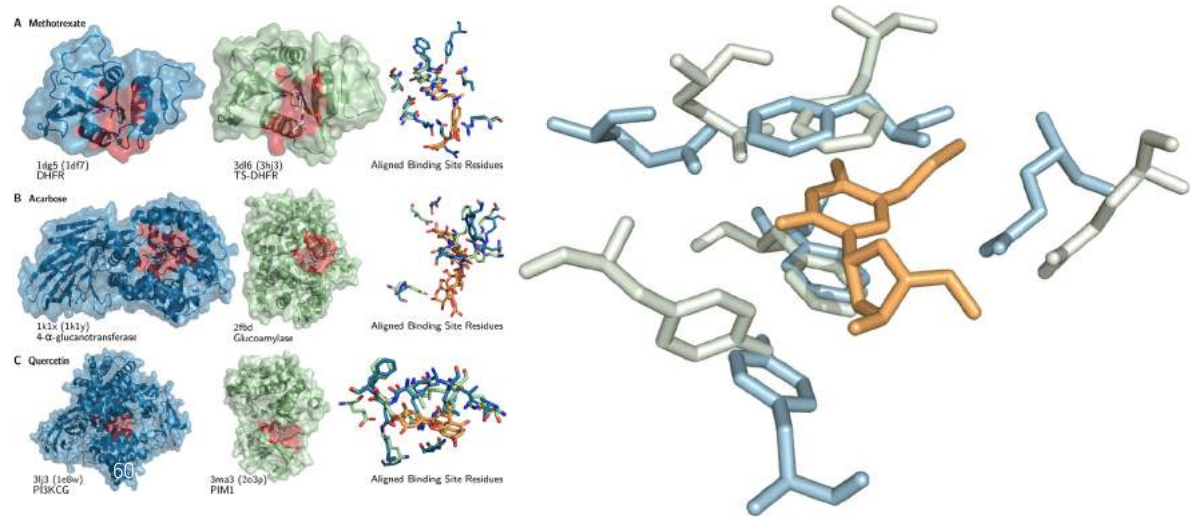

EXPERIMENT #508 HIGHLIGHTS

Industry Sector: **Pharma Industry**

Country: **Germany**

Software used: **In house code**

THE SOLUTION

The use of an HPC-Cloud infrastructure combined with algorithmic improvements enabled substantially better computational performance. This was achieved through the parallelisation of the algorithms used combined with the more efficient use of memory. This resulted in a significant reduction in the time and cost of the evaluation of a single compound. The Cloud-based approach enabled significant computational resources to be deployed without the need to purchase and maintain expensive hardware.

BUSINESS IMPACT

The journey for a drug from invention to market is a long one. There are many challenges to overcome, and many reasons that development of a promising compound may fail. The time required to develop a new drug de novo ranges between 10 and 17 years; that is, if it ever makes it. The chance for a new drug to actually make it to market is only 1:5,000. These slim chances are accompanied by the high cost for developing a new drug, which may reach an average of US\$ 403 million. These rising costs threaten to make the development of new drugs increasingly unaffordable for both companies and patients. Repositioning existing drugs for new diseases could deliver the productivity increases that the industry needs. A prerequisite for drug repurposing is drug promiscuity, a drug's ability to bind to several targets. Here, a HPC Cloud infrastructure demonstrates the viability of a system for investigating previously unknown binding capabilities of existing compounds. Because existing drugs have already undergone extensive safety and bioavailability studies, the cost and time to market of one of these compounds may be significantly reduced. Transinsight estimates that there are hundreds of potential users of its proposed service. Each user represents a potential profit of €2,000 per annum comprising around 4,000 queries regarding protein matching. For Transinsight this represents a potential increase in profits of around 3% per annum.

BENEFITS

- Reduced cost of drug discovery for end users due to pay-per-use query service.
- 3% increase in profit for service provider.



HPC Cloud-based analysis for optical control in manufacturing processes

ORGANIZATIONS

EPC is a Spanish SME specialising in the manufacture of camshafts. These are critical components in high power engines, where tolerances are very small. For this reason, EPC is always working to improve its quality-control process, integrating the latest innovations in hardware and software. The integration and exploitation of 3D optical scanning systems for dimensional quality control in manufacture results in significant benefits in terms of time and dimensional information generated compared to traditional tactile technologies. The use of Cloud-based HPC has the potential to provide a detailed and quick analysis of manufacturing processes enabling significant improvements in the control of quality in production processes.

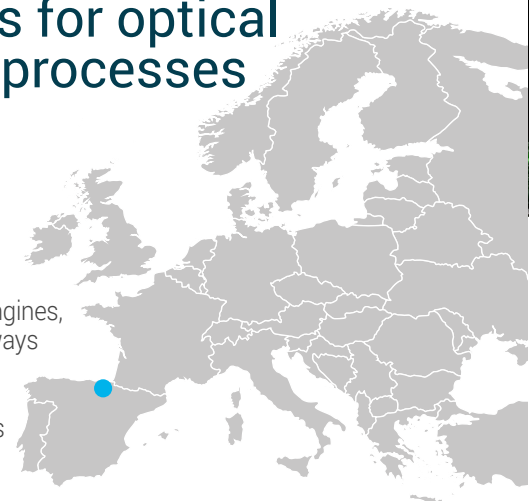

THE CHALLENGE

The challenge of this case study was to develop a service which enables companies, particularly SMEs, to control manufacturing processes with very high accuracy using optical scanning techniques. This requires intensive analysis of the parts to be manufactured using 3D digital information. The combination of scanning, measurement and analysis can identify any problems in the manufacturing process early enough for necessary corrections to be made.



Real part



Virtual part

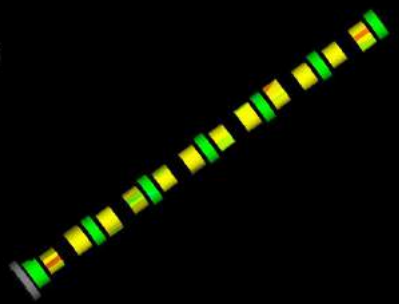

Quality and Manufacturing Knowledge

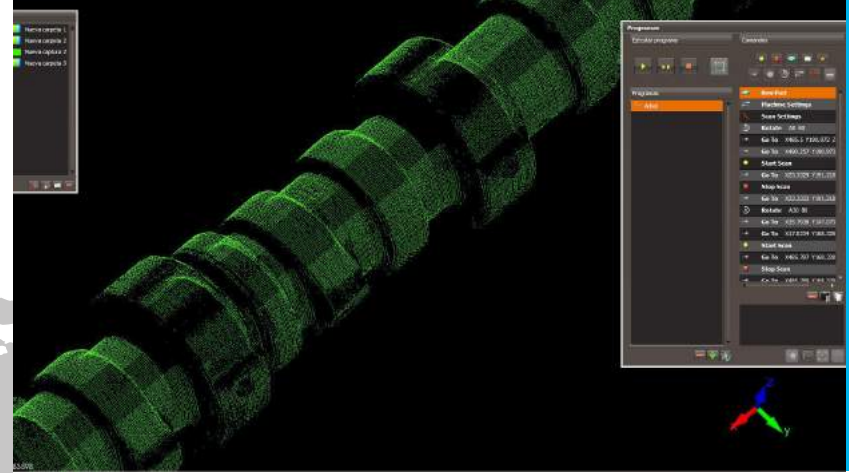

EXPERIMENT #509 HIGHLIGHTS

Industry Sector:
Camshaft Production
Country: **Spain**
Software used:
M3

THE SOLUTION

Cloud-based HPC resources were used, enabling new methods of analysis such as large-scale geometry extraction and temporal analysis of the dimensional quality of large batches. Moreover, traditional tasks such as reverse engineering are now optimised enabling the much faster generation of control data for the production line. This allows the generation of additional information concerning the manufacturing quality at both the part and system levels.

BUSINESS IMPACT

A typical file size for manufacturing data is around 300 Megabytes, representing 15 million points. This means that a single company generates several Terabytes of information in short periods of time to be processed by a service provider such as Unimetrik. At the same time, software developers such as Datapixel have to work on the optimisation of their processing algorithms to enable quicker access to the information contained in the data collected. The use of the HPC Cloud-based service enables a reduction in the time needed to extract dimensional information from 5 minutes to 1 minute. Due to this time reduction:

- Unimetrik will increase its service business by 30% and its portfolio of international customers by 20%. This is expected to lead to an increased turnover of €400.000 over the next five years due to the commercialisation of these advanced services and the creation of two new positions within the company.
- Datapixel, expects an increase of 25% in new licences, representing an additional turnover of €750.000 over the next five years, due to the commercialisation of the optimized data-processing software developed in this case study.
- The end user, EPC, expects to improve the quality of its manufacturing process reducing the production of defective parts down to 0%. This would result in a cost reduction of €1,5 million over the next five years.

BENEFITS

- Reduction in the time needed to extract dimensional information from 5 minutes to 1 minute.
- Unimetrik will increase its services by 30% and its portfolio of international customers by 20%.
- Datapixel expects an increase of 25% in new licenses.
- EPC expects to improve the quality of its manufacturing process reducing the production of defective parts to 0%.



Cloud-based processing of seismic data



ORGANIZATIONS

Seismic Image Processing (SIP) and Sharp Reflections are premiere suppliers of geological and geophysical services, with a strong reputation for integrated processing, depth imaging, and rock physics. SIP and Sharp Reflections offer a wealth of experience and proprietary technologies which provide clients with unique and innovative solutions. SIP is the end user of the Pre-StackPRO software tool, developed by Sharp Reflections. Sharp Reflections is an innovative software company bringing fast, full-survey pre-stack computing to the interpreter's desktop. The application Pre-StackPRO harnesses the power of many-core CPUs to deliver visual, real-time affordable processing via the Cloud. Sharp Reflections defines a leading edge in seismic data analysis.



THE CHALLENGE

As the Oil & Gas industry has had to deal with more and more complex geological targets, high-resolution processing of seismic data and interpretation of results has become strategically important. Pre-StackPRO addresses this need by taking advantage of innovative and powerful computation and visualization capacities. Oil & Gas SMEs cannot afford HPC clusters, and therefore do not benefit from the software's full scaling capabilities.

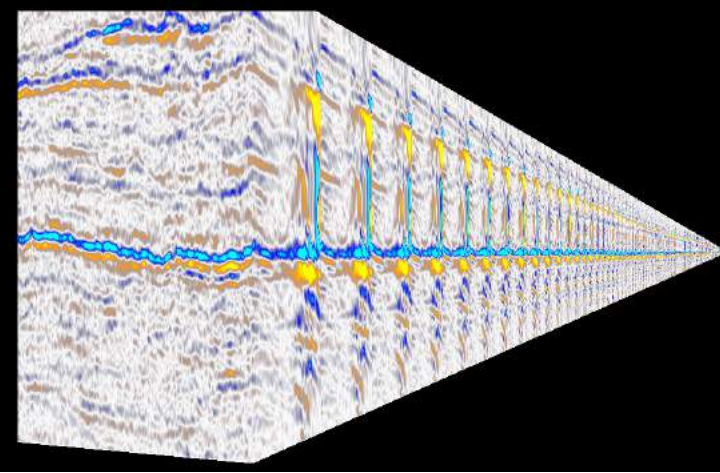
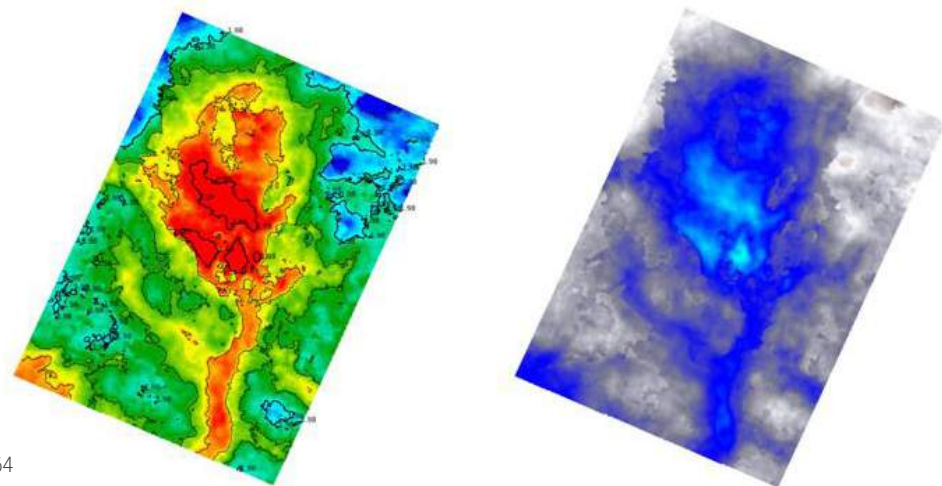

EXPERIMENT #511 HIGHLIGHTS

Industry Sector:
Oil & Gas
Country: **Norway & United Kingdom**
Software used:
Pre-StackPro

THE SOLUTION

Significant changes to the underlying software architecture of Pre-StackPRO have been made, including fully decoupling it from a specific hardware infrastructure, so end users can choose the datacentre and hardware that best fits their needs. With the implementation of Pre-StackPRO in the HPC Cloud it is now available from any remote location through remote desktop connections, which enables new business models and opportunities for collaboration on seismic datasets.

BUSINESS IMPACT

A common configuration for in-house seismic processing by SMEs using Pre-StackPRO comprises a perpetual software licence costing €87.000 plus 20% annual maintenance. The software runs on a 2-node in-house system costing €40.000, with annual maintenance costs of €4.000. Over 4 years, this gives an annual cost of ~€55.000, regardless of the number of hours of processing on the system. These costs are an obstacle to SMEs, and this setup has obvious limitations - when the processing requirements are high, they cannot be met by the in-house system, and when they are low, expensive hardware and software are not being used. Based on the outcomes of this experiment, Bull is offering a compute node with Pre-StackPRO installed and licensed as a Cloud-based service. Such nodes can be purchased on a pay-per-use basis ranging from 1 week to 3 years. Clearly the advantage of such an offering is that variable workloads can be easily and cost effectively accommodated. Savings, over the in-house solution, of between €20.000 to €30.000 for each SME can be expected. Furthermore, the flexible pay-per-use approach enables much larger data-sets to be processed by scaling up the hardware as needed. It is expected that the provision of such a service will increase Sharp Reflection's total revenues significantly - about 1 million €, equivalent to 10% of total revenues in 2017, gradually increasing to 4 million € and 23% of total revenues in 2022.

BENEFITS

- Savings, over the in-house solution, of between €20.000 to €30.000 for each SME are expected.
- The flexible pay-per-use approach ranging from 1 week to 3 years enables larger data-sets to be processed by scaling up the hardware as needed.
- Provision of such a service is expected to increase Sharp Reflection's total revenues up to 4 million € and 23% by 2022.

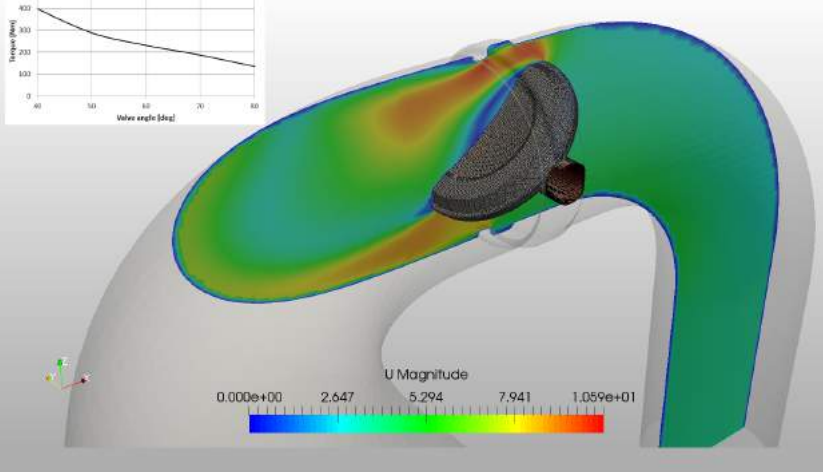

EXPERIMENT #512 HIGHLIGHTS
 Industry Sector: **Oil & Gas**
 Country: **Netherlands**
 Software used: **HELIX**

Cloud-based simulation of pipeline components for the oil & gas industry



ORGANIZATIONS

The Dynaflo Research Group (DRG) is an SME that has provided engineering consultancy services to globally leading oil & gas companies since 1983. This work often requires multidisciplinary simulations encompassing static and dynamic analysis of fluids and mechanical components. To satisfy their advanced modelling requirements, DRG relies on the open-source based CFD software solution HELIX® developed by the ISV ENGYS®. In the past, such simulations were mainly performed on DRG's local systems with a small-scale parallel capability. The objective of this experiment was to enable DRG to run CFD simulations using HELIX® on a Cloud infrastructure, via a familiar desktop environment, which would significantly enhance DRG's simulation capabilities in this area.



THE CHALLENGE

For many SMEs in the engineering and manufacturing sectors, including DRG, in-house computing hardware is usually insufficient for solving large problems. On-demand Cloud-based HPC solutions, combined with open-source software, can offer a more cost-effective alternative. The main challenge faced by DRG and its partner ENGYS was to create a new methodology to perform oil & gas CFD simulations using on-demand Cloud-based HPC solutions.

THE SOLUTION

ENGYS developed and tested a novel client-server framework for their CFD software HELIX® with the help of NAG and DRG. The new client-server framework allows end users to perform CFD simulations on remote HPC hardware directly from a desktop Graphical User Interface. The new technology facilitates access to and effective use of remote HPC resources from a local desktop, such as those employed by DRG. ENGYS could also offer this product on a short-term licence as an on-demand service.

BUSINESS IMPACT

A simple calculation based on the work in this experiment showed that the costs to DRG of buying and maintaining a computer cluster in-house for performing these CFD simulations could be up to 5x the costs of an equivalent Cloud-based HPC solution. There are also clear benefits in turn-around times for simulations, as well as the opportunity to perform much larger computations using a Cloud-based HPC platform. The simulations are up to 10 times faster, with potential savings of €2.000 per simulation per day (based on standard industry rates). The new client-server approach in HELIX® is also expected to increase sale opportunities for ENGYS by as much as 20%, thanks to the introduction of short-terms licenses for on-demand usage of the software in the Cloud. Furthermore, the possibility of providing these resources via the Fortissimo Marketplace should lead to increased revenue by exposure to a wider market. EPCC will see an increase in its commercial activities through extended use of its commercial supercomputer platforms. NAG will create case studies based on this experiment to showcase its capability in software engineering and High Performance Computing. Such marketing materials will be distributed to potential customers to attract new HPC consulting business. Current estimates are that this would result in an additional revenue for NAG in excess of €150.000 over the next three years.

BENEFITS

- Potential savings of €2.000 per simulation per day for end users due to faster simulations and pay-per-use model.
- Capability to perform simulations on a scale previously not possible.
- Increase of 20% in business for the service provider.

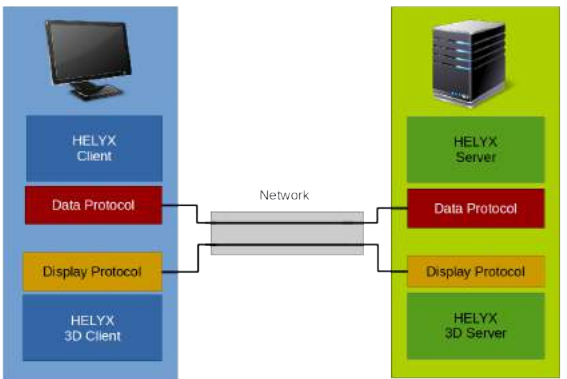



Cloud-based environmental modelling

ORGANIZATIONS

eAmbiente is an SME operating in the area of environmental consulting. It provides its services to architects and designers involved in the design of large factories and industrial plants, characterized by significant environmental impacts. eAmbiente's mission is to reduce these impacts to acceptable levels. Since 2002, eAmbiente has used computer simulation to model emissions and water flow to predict the risk to soil and groundwater. During this period, environmental modelling has become an important tool during the planning phase of buildings, factories and public infrastructures. Although the required simulations are well understood, their performance and ease of use are limited. In particular, models may take prohibitively long run-times on conventional computing resources.



EXPERIMENT #514 HIGHLIGHTS

Industry Sector:
Environmental Assessment
Country: **Italy**
Software used:
Aermod

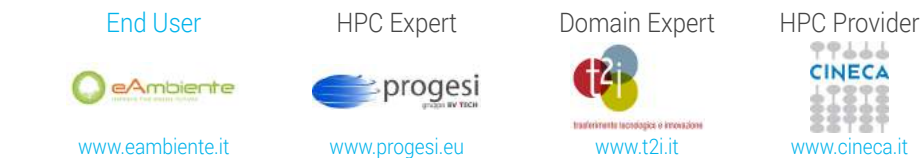
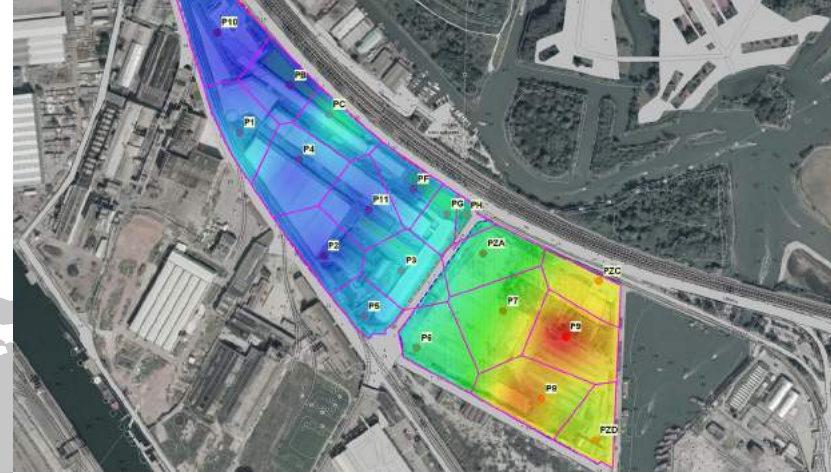

THE CHALLENGE

The challenge of this Case Study is to overcome the current limitations of environmental modelling tools. The main aim is to set up and test an innovative service for SMEs, public sector and private stakeholders through a single access point. This includes a Cloud-based service that will launch and aggregate the results of different models in parallel and an offline service used to evaluate and interact with the results of the simulations.

THE SOLUTION

This issue has been addressed through the development of a customized platform to integrate environmental software including a single easy-to-use GUI available to potential end users. This GUI gives one-stop access to Cloud-based HPC resources for the end user. The use of this solution enables an 80% reduction in both simulation time and time to result with consequent cost benefits. Furthermore, the use of open-source software for the simulations has resulted in a significant reduction in costs.

BUSINESS IMPACT

The total cost of running a single traditional Environmental Impact Assessment (EIA) on a powerful in-house system is ~€30.500. The same assessment, using open-source software, Cloud-based HPC resources and reduced staff effort is ~€6.500, a saving of ~€24.000 per EIA. eAmbiente expects to carry out an additional 4 EIAs yearly over each of the next five years resulting in an overall cost saving of ~€64.000 per year. Furthermore, eAmbiente expects to increase its revenue with around €374.000 of additional business over the next five years, corresponding to about €75.000 per year. eAmbiente has a revenue of about €270.000 per year for the EIA sector. The experiment can generate an increase of 28% in that yearly revenue. As a result of the experiment, two new employees over the next five years is expected. Finally an increase in competitiveness at the European level is anticipated since the workflow is easily customizable to European environmental legislation. T2i will develop a brand new EIA-related service starting from scratch. There is no such (digital) service in T2i's portfolio. T2i estimates a 5% increase in commercial revenues in the next two years corresponding to an expected increase in sales of €5.000 to €10.000 per annum. Finally, this experiment offers a success story for CINECA. It is estimated that this will bring at least one new customer per year, with an approximate 5% increase in revenues from commercial services.

BENEFITS

- The experiment can generate an increase of 28% in yearly revenue.
- Increase in competitiveness at the European level.
- 5% increase in commercial revenues in next two years.

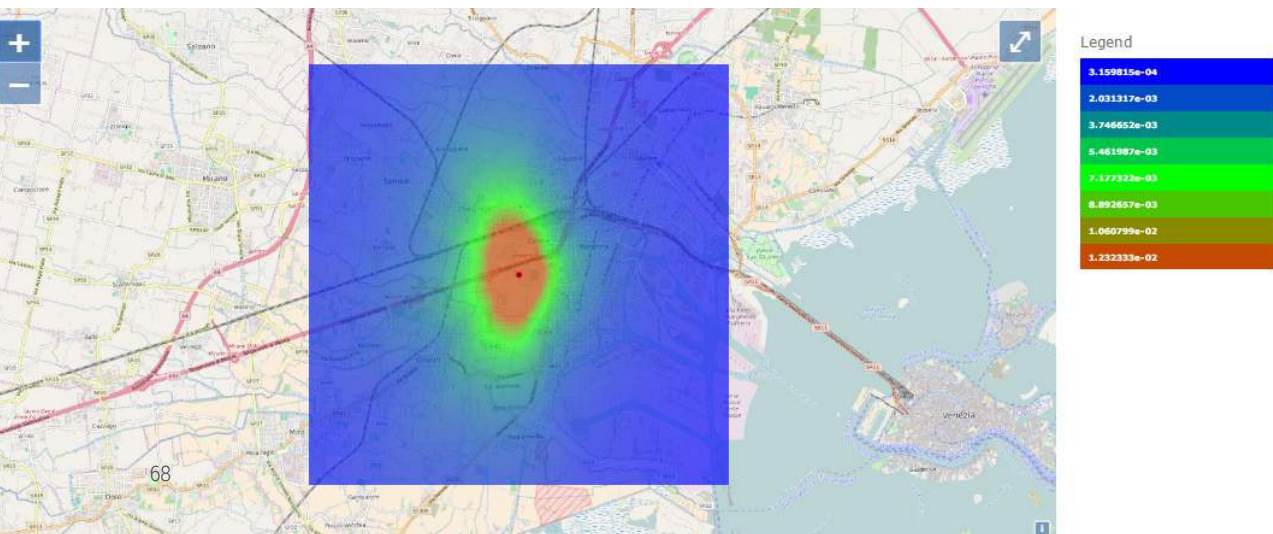



HPC Cloud-based additive manufacturing

ORGANIZATIONS

HSL is an SME and a market leader in both Additive Manufacturing and the rapid production of prototypes. In recent years Additive Manufacturing has emerged as a viable mainstream production technology. Overcoming technical and bureaucratic obstacles has allowed 3D printing to grow as a cost-effective option for small and medium scale production together with the ability to produce complex shapes not achievable by standard manufacturing processes. This flexibility in design enables the optimisation of components, a reduction in manufacturing time by almost a third and a halving of production costs by reducing the waste of materials and energy.



EXPERIMENT #515 HIGHLIGHTS

Industry Sector: **Automotive**
Country: **Italy**
Software used: **RBF Morph**

THE SOLUTION

Numerical grid parameterisation using a mesh morpher avoids the time consuming task of mesh generation (that can take up to 70% of the total analysis cost). Access to CFD simulation through the Fortissimo HPC Cloud allows a speed-up in calculation times reducing the time to market and to return on investment. Using a collaborative, interactive, Cloud interface helps analysts and clients to work together, increasing customer satisfaction and building better products more effectively.

BUSINESS IMPACT

HSL expects that the new service will see the development of a business department with two to three staff, potentially growing to five to six staff after three to four years. For UTV it is estimated that thanks to the new know-how acquired the relevant department will increase its industrial research services. The economic benefit is estimated to be between €40.000 and €70.000 per year in a five-year plan. Finally, this case study comprises a success story for CINECA, in the application field of high fidelity CFD, that is estimated to bring in at least two new SME customers per year, with an approximate 5% increase in revenue for commercial services.

Having access to the RBF Morph morphing tool combined with CFD analysis powered by HPC opens a wide range of business opportunities. In parallel with existing rapid prototyping services, HSL can now propose to its clients alternative component designs corresponding to appropriate performance indicators. For HSL, offering a shape optimisation service in parallel with its existing core business of rapid prototyping activities, represents an opportunity to establish customer activity over a range of key R&D areas. HSL is ready to offer the developed tool to a range of existing clients in the automotive industry, anticipating for the next two years, a total revenue growth of 16% per year in that sector.

BENEFITS

- 5% increase in revenue for commercial service.
- New business service for optimisation of airbox components total revenue growth of 16% per year in that sector.

THE CHALLENGE

Computer-aided engineering (CAE) tools are able to suggest new shapes and accurately predict the behaviour of components, making them a natural choice in the design chain, but can be prohibitively expensive for SMEs. This is especially true when dealing with complex Computational Fluid Dynamic (CFD) simulations. The goal is to demonstrate the validity of an optimisation service using CAE by optimising a Lamborghini 12-cylinder airbox.

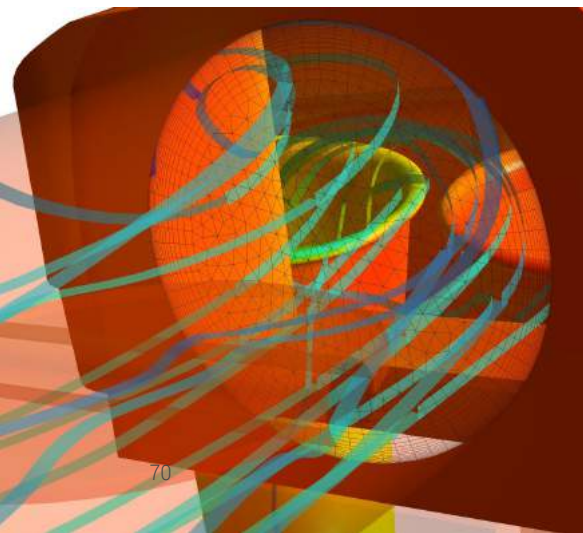



Advanced simulation for metal forming



ORGANIZATIONS

MATRICI is a Spanish SME founded in 1964, specialising in the production and design of complex metal panels in the automobile and aerospace industries. The sheet metal forming industry is important in the development of the world's economy. The use of HPC-based simulation can have a significant financial impact on the manufacturers of such panels. However, despite recent significant advances in computing hardware and software, high-end computer simulation and engineering design tools are often unaffordable for small companies because of the large capital investment in computing power required. This experiment demonstrates the benefits of advanced Cloud-based HPC tools in design and how these can be delivered as a pay-per-use service, affordable by small companies.

End User



www.matrici.com

Technology Expert



www.scai.fraunhofer.de

ISV



www.quantech.es

HPC Provider, Expert & Host Centre



www.cesga.es

THE CHALLENGE

The challenge here was to develop a software solution that allows industry to simulate metal forming with higher efficiency and ease of use than possible using today's state-of-the-art commercial codes. Stampack, a simulation code available from QUANTECH, models the forming of sheet metal panels. However, the application would need to be modified to be able to run effectively in a Cloud of HPC resource on a pay-per-use basis.

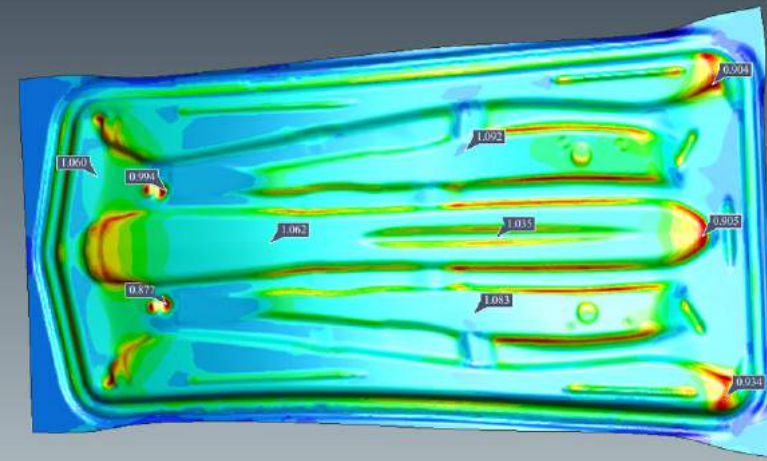
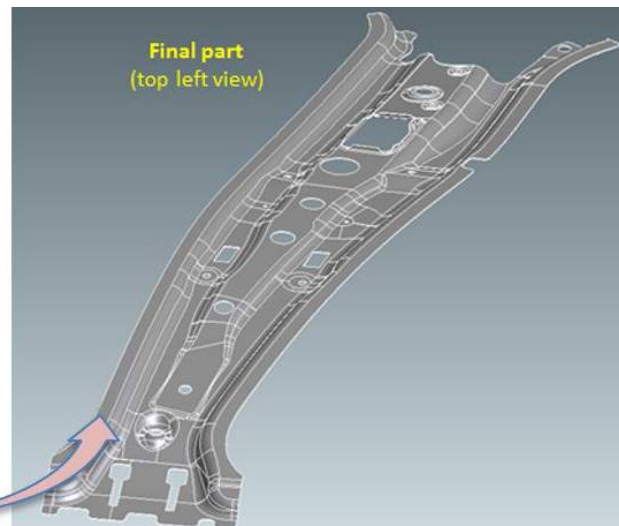
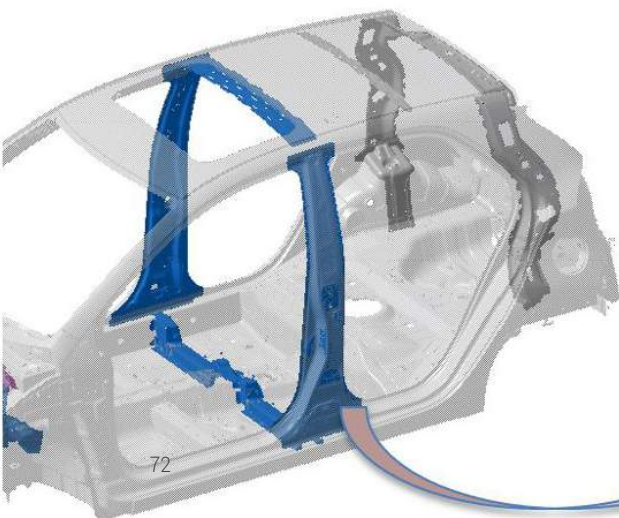

EXPERIMENT #516 HIGHLIGHTS

Industry Sector: **Automotive**

Country: **Spain**

Software used: **Stampack**

THE SOLUTION

A Cloud-based version of Stampack (StamHPC) has been adapted, developed and validated, and its performance and usability evaluated in an industrial setting. A graphical interface offers easy and intuitive use in the metal forming industry. This allows any end user, even without HPC expertise, to launch a calculation and get results with an appropriate response time. Furthermore, an appropriate licensing server has been developed which supports the availability of StamHPC on a pay-per-use basis.

BUSINESS IMPACT

MATRICI estimates that the use of the Cloud-based StamHPC in its design processes is worth an additional €200.000 in revenues per year. QUANTECH and CESGA expect around 300 new metal forming SMEs to use StamHPC over the next 5 years, leading to a potential return on investment of €60 million. A typical simulation to support the design of a metal forming process takes around 120 iterations, each of which needs 20 computing hours on a standard workstation (8 cores, 32 GB of memory). Such a simulation represents 10 weeks of work involving a workstation and an engineer. Using the StamHPC solution within an HPC Cloud it is possible to run, at the same time, several options of the feasibility design concepts, reducing the time required to design a prototype. The reduction of time to solution is about 50%, with similar cost reductions. A company like MATRICI performs 200 Feasibility design studies per year in order to make offers to customers, the reduction of design costs, plus the accuracy of the new StamHPC software would represent savings around 1,5 million €/year (2,5% of current company turnover for MATRICI). CESGA estimates that it will see, due to the sale of computer cycles as a result of the Cloud-based StamHPC, an additional annual revenue of €45.000 in 2017 growing to €365.000 in 2021. SCAI will use the success of this experiment as a reference to support the sales of its software products, particularly those relevant to HPC-based Clouds.

BENEFITS

- A minimum additional revenue of €200.000 per year is estimated by the end user (through the use of a Cloud-based StamHPC in its design processes).
- Using the StamHPC solution within an HPC Cloud makes possible to run simultaneously several options of the feasibility design concepts.
- The reduction of time to solution is about 50%, which means an overall reduction of engineering costs of 50%.



Optimised cutting and bending of steel reinforcement bars using Cloud-based HPC



EXPERIMENT #517 HIGHLIGHTS
Industry Sector: **Building Industry**
Country: **Spain**
Software used: **Optimo**

ORGANIZATIONS

Schnell Software, a Spanish SME, designs specialized CAD-CAM software for companies which cut and bend steel, particularly the cutting of iron bars for reinforced concrete. SCHNELL already has optimisation software running on a PC; however, execution take several hours if high levels of optimization are required, which is impractical in a production environment. The optimisation of cutting and bending of iron bars is based on complex algorithms which are numerically intensive. Better optimisation would enable SCHNELL's customers to plan their schedules to obtain the best possible combination of orders, minimising wastage in the cutting and bending process, and saving time in the analysis of production orders and raw material requirements.

End User & ISV



www.schnellsoftware.com

HPC & Application Expert



www.bifi.es

HPC Provider, Expert & Host Centre



www.cesga.es

THE CHALLENGE

The challenge facing SCHNELL was to modify its software to run on a Cloud-based HPC system rather than a local PC. The objective was to reduce the compute time from hours down to minutes for even large-scale optimisations, and develop a graphical user interface for users. The modified software would serve as a database portal and clients would be able to carry out a real simulation of a cutting process with minimal cost and effort.

THE SOLUTION

The optimization software has been adapted to run in a distributed Cloud-based HPC infrastructure. Through the use of a graphical user interface it is easy to setup and optimise bar cutting and bending optimisations. This hides all the complexity of the Cloud. Launching optimisations is as simple as sending some input files, with appropriate parameters and receiving the results after a manageable processing time.

BUSINESS IMPACT

A large foundry produces 2.000 tonnes of steel bars per month. Through the use of Cloud-based high-level optimisation, it can reduce waste steel by 2% (480 tonnes per annum). The average price of steel is €500 per tonne, so this represents a saving of €240.000 per annum. A lower-level optimisation offers savings of only around €60.000 per annum. The higher-level optimisation also results in a €30.000 reduction in staff costs. For small companies, acquiring an in-house optimization system that guarantees a reliable cut of high quality requires significant investment in hardware and software. Not all small and even large companies are willing to do this because they are not sure of the benefits. This barrier can be overcome using a Cloud-based, pay-per-use approach as companies can test and evaluate the service without a large capital investment. A simple analysis of the costs of performing the high-level optimisation in-house on a sufficiently powerful system results in a yearly expenditure of €80.000. The corresponding computing costs of performing the same optimisation in the Cloud are only €7.500 per annum. Over 5 years SCHNELL estimates a total income of ~€480.000 from the provision of its Cloud-based optimisation service to steel foundries, including Cloud-computing and SCHNELL licence costs, resulting in a total profit of ~€440.000. In addition to this, CESGA will increase sales of computer cycles by around 175.000 CPU hours per year.

BENEFITS

- Steel waste reduction by 2%, which represents 480 tons per year.
- Reduction in staff costs by €30.000.
- Over five years, Schnell estimates a total profit of €440.000 from the provision of its Cloud-based optimisation service.

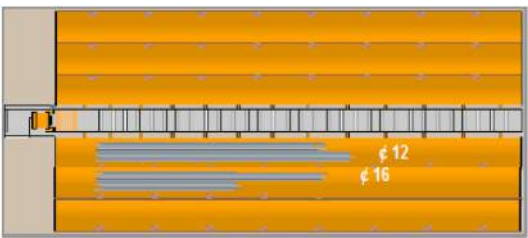



Cloud-based optimisation of water turbines for power generation

ORGANIZATIONS

Zeco is an Italian SME in the renewable energy sector. It specialises in the production of different types of water turbine. SMEs like Zeco must develop and innovate their products to remain competitive. High-fidelity simulation using CFD has become an essential tool for turbine designers because it results in better designs for less effort and lower cost. However, for Zeco and, in general for SMEs, full exploitation of CFD tools is often not possible as they lack the necessary computing power, and the skills to exploit it effectively. The objective here is to demonstrate how all the necessary resources can be assembled to give ZECO a one-stop-shop for the simulation of turbines leading to business benefits across the whole value chain.



End User



www.zeco.it

HPC Expert



www.enginsoft.com

ISV



www.ansys.com

HPC Provider



www.cineca.it

THE CHALLENGE

Current practice in the design of hydro-power plants is to determine the most suitable design in a series of time-consuming experiments. However, SMEs in this sector face stiff competition and tight deadlines to sell their turbines in both national and global markets. The challenge facing Zeco is to improve its design processes by the use of HPC-based high-fidelity simulations of flow in its turbines through the use of CFD-based tools.

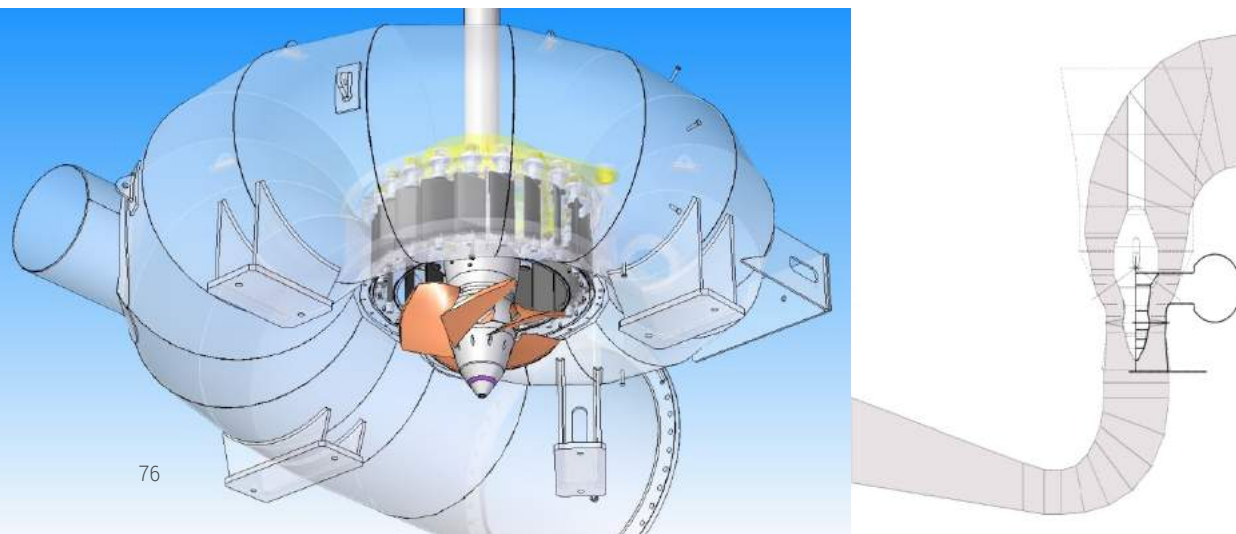

EXPERIMENT #519 HIGHLIGHTS

Industry Sector:
Hydraulic Turbines

Country: **Italy**

Software used:
ANSYS CFD

THE SOLUTION

A CFD-based HPC application has been developed which enables the design of a small hydro power plant in a very fast and reliable way, compared to current practices. The use of this application can contribute significantly to savings in time and money in the development of new water-turbine systems. High-fidelity simulations and the availability of HPC significantly reduce the development costs of prototypes, so the time to market is also significantly lower.

BUSINESS IMPACT

HPC-based CFD calculations have reduced the design time of a turbine from 1 year to 3 months. As manufacturing the turbine takes 8 months, the time to market can be reduced from 20 to 11 months. Without the use of HPC, the development process could take up to two years, which is no longer a competitive time frame in this sector. Using such turbines, a medium-sized hydropower plant costing 1,5 million € can reduce operational costs by €350.000 per installation over two years. Furthermore, the optimization through HPC leads to a 1% increase in plant efficiency, with a 50% reduction in the total number of days required for maintenance. This means an increase of the revenue related to energy production of up to 40.000€ per year per installation. Due to these improvements, Zeco expects to increase its market share by at least 5% with an additional profit of €50.000 per year. As a result of the increased market for advanced simulation using HPC, EnginSoft expects a growth of 10% in business related to the turbo-machinery market sector, which means an additional profit of around €50.000 per year. CINECA estimate potential revenues for the HPC service of €100.000 per year. The workflow developed here is applicable to other sectors as well, so there is a large potential market. CINECA's target is to acquire two customers for this service per year for the next three years, with an estimated increased revenue of €900.000 and a profit of around €100.000.

BENEFITS

- Reduction of designing time from 1 year to 3 months.
- Reduce operational costs by €350.000 per installation over 2 years.
- 1% increase in plant efficiency, 50% reduction in total number per days of maintenance.
- Increase by at least 5% in market share.



HPC-based prediction of the optical properties of dyes



ORGANIZATIONS

Scriba Nanotechnologie is an SME active in the fields of smart packaging, health, and machine vision. In particular, Scriba is involved in the development of Time Temperature Integrators (TTIs), which are devices that record the thermal history of products. Placed close to perishable products, they can be used to monitor the thermal history of packaging and storage conditions. TTIs form an important part of cold chain logistics in a world where production is global. TTIs use dyes which may change if there is a change in temperature. This experiment uses molecular dynamics to simulate dyes used in the manufacture of new and innovative TTIs. Simulations reduce the time to customise these devices, thus lowering the overall cost.

End User



www.scriba-nanotec.com

HPC Expert & Provider



www.cineca.it

Domain Expert



www.topc.univaq.it



www.unimore.it

THE CHALLENGE

The challenge faced by this experiment is to use HPC to simulate candidate dyes, based on molecular dynamics, to be used in the fabrication of innovative TTIs. This requires a multidisciplinary approach using molecular dynamics-based simulations of dyes. The aim is to reduce the time required for customisation of TTIs, lowering the overall cost of these products. The goal is to develop a new tool in cold chain logistics.

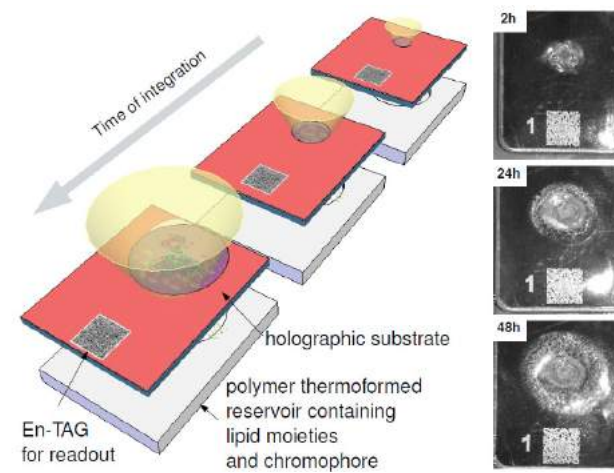

EXPERIMENT #520 HIGHLIGHTS

Industry Sector: **Pharmaceutical Engineering**

Country: **Italy**

Software used: **Perturbed Matrix Method (PMM)**

THE SOLUTION

A computational pipeline for the simulation of optical properties of dyes in different environments has been set up and a Cloud-based web portal has been developed to manage the simulations. This portal has been specifically designed for users with no expertise in simulation - the user only needs to select the material of interest and the experimental conditions to be simulated, and default options are presented to help the user proceed through the steps.

BUSINESS IMPACT

Through the use of the advanced simulation package, Scriba expects to see a saving of €90.000 per simulation in the first year of use, with further savings of €70.000 in subsequent years. This can be broken down as savings in personnel costs of €45.000, in infrastructure costs of €10.000, in material costs (including computing costs) of €25.000, and optical readout and further development of €15.000 in the first year. Scriba estimates that it will be involved in approx. 6 simulations per year resulting in an annual saving of around €400.000. CINECA plans to use the success of this experiment to target SMEs in the European market who have the need for high-fidelity chemical and molecular dynamics simulations. The target is to acquire two customers of this type per year in each of the following three years. UNIMORE and UNIVAQ expect to see an increase in their consultancy business as a result of this successful experiment. Both partners will be further involved in the enhancement of the software, operating as external consultants. The value of the external consultancy to the two domain experts is estimated to be ~€10.000 per year each. The number of potential users to run simulations explicitly for the development of temperature sensors is about 5 and for the design of optical (bio)sensors about 100. Scriba will make available the developed virtual tool in the Fortissimo Marketplace, subject to appropriate terms and conditions.

BENEFITS

- Annual savings of around €400.000 per year.
- Value of the external consultancy to the two domain experts is estimated to be €10.000.
- Development of virtual tool.





Multi-physics simulation of high-temperature superconducting devices



ORGANIZATIONS

Oxolutia is a technology-based Spanish SME specialising in thin-film oxide architectures. These are deposited by industrial inkjet printers using special inks. Oxolutia has investigated the high-temperature superconductor (HTS) space as a potential new market for them to move into. These materials can be used to construct generators, motors and superconducting magnets, for applications such as power cables, energy storage and magnetic resonance imaging (MRI) devices. However, they are complex and difficult to work with, exhibiting strongly non-linear hysteretic behaviour and time-dependence. This requires a robust, fast and powerful computing environment to obtain solutions consistent with a productive design cycle.

End User	HPC Expert	ISV	HPC Provider
www.oxolutia.com	www.icmab.es	www.cimne.com	www.cesga.es

THE CHALLENGE

The challenge was to develop a design tool that could calculate the required properties of HTSs - magnetic, electric and current density fields, and mechanical and thermal properties including temperature, stress and strain fields – in a reasonable time frame. This was done using FEMPAR, an electromagnetic software package from the ISV CIMNE. The results of the modified FEMPAR package were verified by comparison with other commercial solvers.

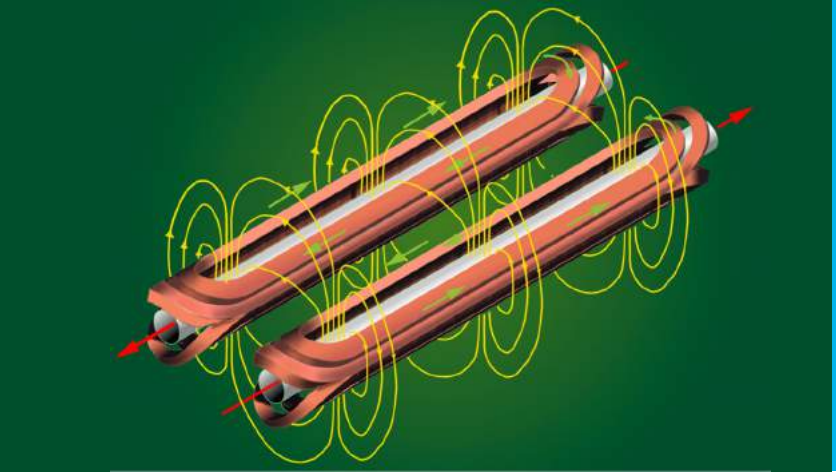
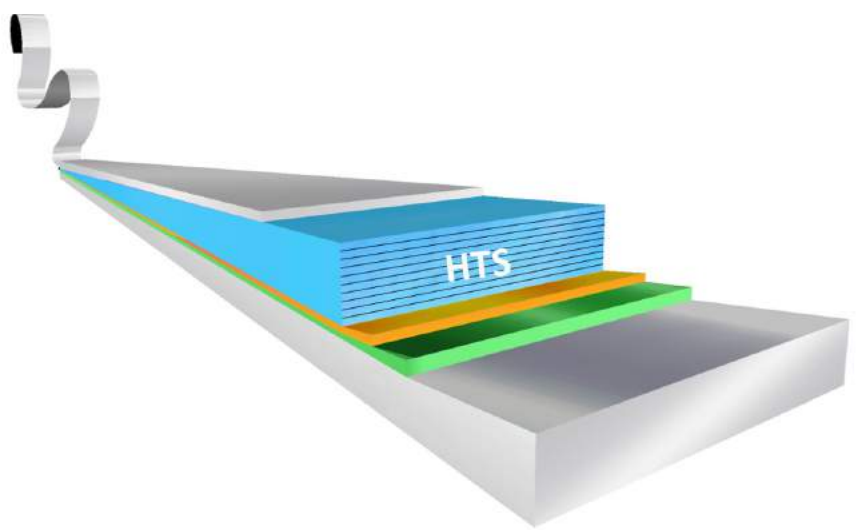

EXPERIMENT #521 HIGHLIGHTS

Industry Sector:
Electromagnetic Components Industry

Country: **Spain**

Software used:
FEMPAR

THE SOLUTION

In order to reduce computation times to reasonable levels, a multiphysics-based HPC application has been developed which enables the behaviour of HTS devices to be simulated. The use of this application can contribute significantly to savings in time and money in the development of devices adapted to meet customer demands. It enables Oxolutia to understand the performance and characteristics of its products, and to increase their competitiveness by allowing them to enter a new business area.

BUSINESS IMPACT

High-fidelity simulations and the availability of HPC can significantly reduce the development costs of prototypes. In this experiment, this has opened up a new market for the SME involved, Oxolutia. Through the use of this service, Oxolutia expects to see an increase in business turnover of €25.000 over the next year. This is based on the sales of HTS devices - production costs, licence fees and computer cycles would cost €12.000, giving Oxolutia a net profit of €13.000 in the first year. Looking over the next 3 years, Oxolutia expects to see an increase in business turnover of €500.000, spending €150.000 on production costs, licence fees and computer cycles - a net profit of €350.000.

CESGA and CIMNE plan to offer a service enabling SMEs to simulate the electromagnetic and physical behaviour of HTS devices. This service will be offered on a pay-per-use basis including licence fees and the costs of computing cycles. CIMNE anticipates a net profit of €54.000 from related new business over the next 3 years due to the provision of service. Over this period CESGA expects to increase its provision of CPU cycles to CIMNE by 32.000 core hours.

ICMAB, the HPC application expert, expects a profit over this period of €45.000 based on increasing of consultancy and research contracts using the pay-per-use service.

BENEFITS

- A new business turnover of €25.000 over the next year is expected by the end user, of that €13.000 of net profit.
- ISV CIMNE anticipates a net profit of €54.000 from related new business over the next 3 years due to the provision with CESGA of the pay-per-use simulation service.



HPC-Cloud-based monitoring of crowds



ORGANIZATIONS

DFRC is a leading centre for knowledge, research, and development of geospatial data. Its expertise lies in crowd monitoring and smart cities. DFRC delivers powerful end-to-end solutions using data about the location and the movement of people using a suite of tools, software platforms and applications. DFRC operates LBASense, a service which anonymously measures crowd behaviour on a city-wide scale. This information is highly valuable for services such as transportation planning, the promotion of tourism and public safety applications. LBASense, which currently operates in Bern, Zug, Skelefteå, Barcelona, Prague, and Singapore, requires an extensive "fingerprinting" of the cellular network radio signals in order to calculate the location of mobile phones.

End User



HPC Provider



THE CHALLENGE

The challenge of this experiment was to improve the process of "fingerprinting" a city, by offering a near-real-time simulation to determine the best locations at which to take measurements. Doing this was expected to reduce the time to map a city from weeks to days. To respond to this challenge, the mapping algorithm, which determines the best locations for measurement points, would need to be ported to a Cloud-based HPC system.

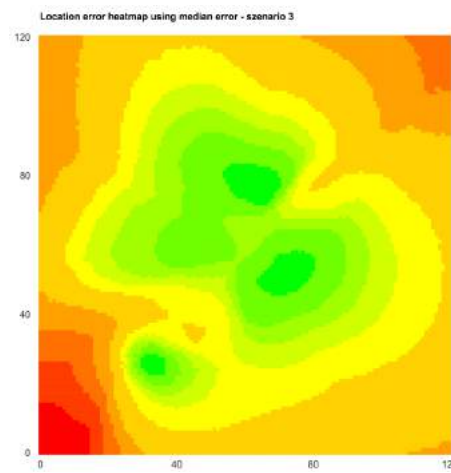

EXPERIMENT #522 HIGHLIGHTS

Industry Sector: **Smart Cities**
Country: **Switzerland**
Software used: **LBASense**

THE SOLUTION

Existing simulation tools have been ported to enable them to run on an HPC system with many processors. Detailed tests have been made to verify the correctness, accuracy and stability of the ported algorithm and to determine the speed up of the implementation. The outcome of the experiment has been a High Performance combined simulation tool that reduces the deployment time of LBASense. This allows DFRC to finish a single iteration of the simulation within hours as opposed to days.

BUSINESS IMPACT

The ability to access a cost-effective, one stop-shop, Cloud-based HPC service has enabled DFRC to significantly reduce the deployment costs of LBASense. This saving is as a result of the reduction in time to deployment, allowing DFRC to save the costs of two weeks each for two engineers per deployment, which is approximately €25.000. The results show that DFRC is able to speed up the whole process of mapping a city (i.e. 1.000 base stations – 10x10 km) by a factor close to the number of processing units available. That is, with 32 processing units it is possible to speed up the computation process by a factor of almost 32. This allows DFRC to offer a cheaper, faster and more focused service, and hence to be more competitive with respect to cellular operators. DFRC expects to gain new market share, especially by being able to reduce time to market. Based on the overall costs of installing LBASense in a city, and the speed with which it can be done, DFRC expects to see a growth in its business from 20 installations in 2017 to 200 in 2021 with an overall cost saving of ~€8 million.

HLRS, the HPC provider in this experiment, benefits from the experiment through an increased knowledge about commercially relevant scenarios leading to improved offerings for a wider range of customers, which will increase its competitiveness.

BENEFITS

- Reduced deployment costs for LBASense by ~€25.000.
- DFRC is able to offer a cheaper, faster and more focused service and hence, be more competitive with respect to cellular operators.
- Expected growth in DFRC's business from 20 installations in 2017 to 200 in 2021, with an overall cost saving of ~€8 million.



Cloud-based design of motorcycle helmets



ORGANIZATIONS

The NolanGroup is a Mid-Cap Italian company that are one of the leading manufacturers of motorcycle helmets worldwide. Nolan produces helmets for professional, leisure and racing activities, participating in the main international motorcycle competitions. Nolan wants to enhance its helmet design capabilities to reduce costs and time to market through the use of advanced HPC-based simulation. Moxoff is an Italian SME developing mathematical modelling software, and has been in partnership with Nolan since 2010. Moxoff's projects cover a wide range of applications, including multiphysics modelling, numerical simulations, statistics and big data analytics. CASCo is a dedicated multiphysics platform developed by Moxoff to support the simulation of Nolan's motorcycle helmets.



THE CHALLENGE

Nolan have only recently introduced a simulation-based approach using CASCo to simulate external aerodynamics, thermal effects, acoustics, and impacts of its helmet designs. The choice of computational platform here is critical, as the right choice can reduce compute times by orders of magnitude. The aim of this experiment is to enable advanced and fine detail simulations with feasible runtimes through the use of HPC via the CASCo platform.

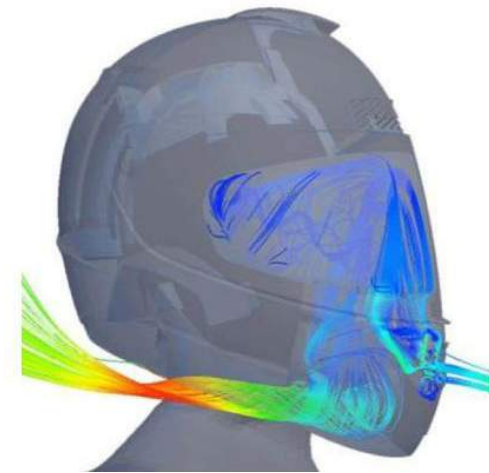
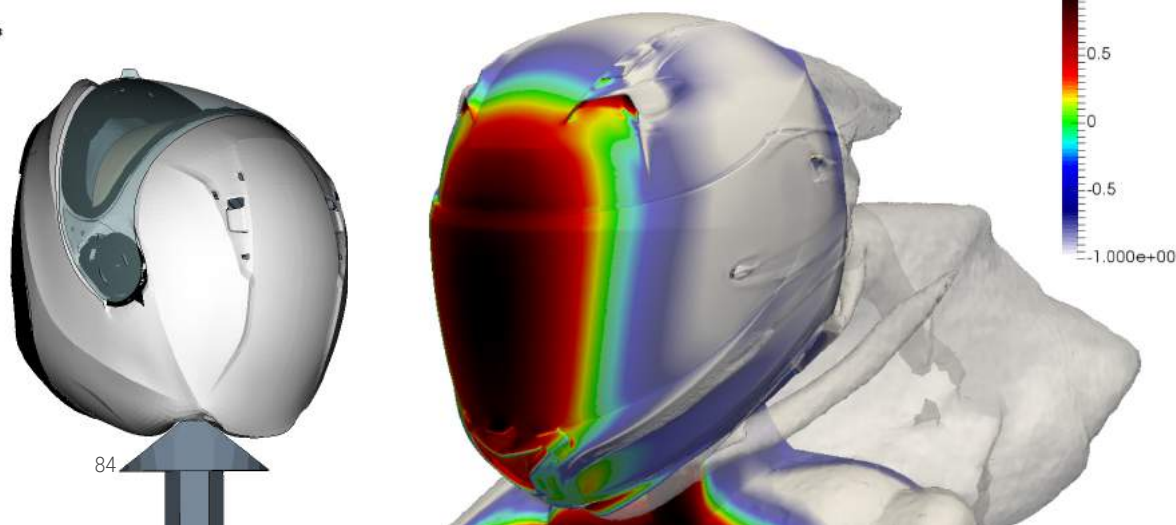

EXPERIMENT #601 HIGHLIGHTS

Industry Sector: **Automotive**
Country: **Italy**
Software used: **In house code**

THE SOLUTION

The CASCo Multiphysics platform has been ported to an HPC system. This enables detailed models to be simulated in a simple way by those not expert in the underlying physics. This has involved the enhancement and customisation of GUIs, workflows and file formats, and the development of the interface with an HPC scheduler system. These enhancements have achieved the aim of allowing non-experts to perform detailed simulations and to make their results easily accessible and in a much shorter timescale.

BUSINESS IMPACT

In this experiment, a powerful simulation platform has been developed by Moxoff which can be easily configured to provide Simulation-as-a-Service using massive HPC computing resources, even across totally different industries. Nolan can either use its own IT resources or, for time sensitive simulations, use a pay-per-use service hosted in the CINECA HPC facilities. Moxoff estimates that its exploitation of the SaaS and the platform will increase its turnover by 10% and will significantly contribute to its planned growth for the coming 3 years. Furthermore, through the wider development of this platform, Moxoff will reduce its software development costs by €50.000 per year. Nolan estimates that, for each new helmet developed, the use of HPC simulations will save money in physical prototype testing and final product tuning. This new approach will provide a net saving of €52.000 per helmet once the cost of compute cycles and software licences are deducted. Furthermore, advanced simulations will lead to a 3-month reduction in the current 15-month development cycle which can have important implications for Nolan's market impact. Finally, this experiment comprises a success story for CINECA, in the application field of integrated multiphysics workflows, that is estimated to bring at least two new SME customers per year, creating an approximate 5% increase in commercial revenues.

BENEFITS

- Platform will increase its turnover by 10%.
- Reduce software development costs by €50.000 per year.
- 5% increase in commercial revenues.



Simulation of High-Performance composite materials in the automobile industry

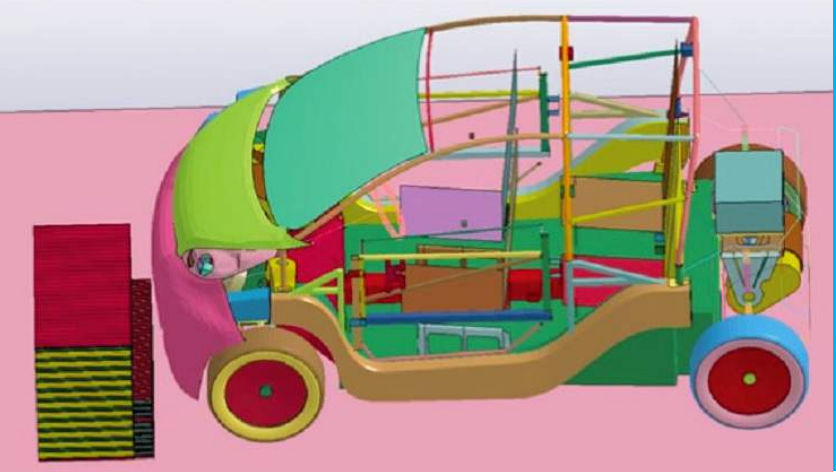

EXPERIMENT #602 HIGHLIGHTS

Industry Sector: **Manufacturing**

Country: **United Kingdom**

Software used: **In house code**

ORGANIZATIONS

Formtech Composites specialises in the design, engineering and manufacture of lightweight composite structures and components, using carbon, glass, aramid, and other High Performance fibres. It collaborates with leading automotive, motorsport, military and aerospace partners to take forward composite research, engineering, prototyping and serialised manufacture. The industrial use of carbon-fibre-reinforced plastic (CFRP) is being driven by the increasing use of composites to reduce weight in the automotive industry, where cost and performance are major factors. With world-wide tooling budgets running into hundreds of millions of Euros, simulating processes and manufacturing times are central to delivering high-quality products at an affordable price.

End User	ISV	Domain Expert	HPC Provider
www.formtech-composites.co.uk	www.scai.fraunhofer.de	www.fast.kit.edu/lbt	www.gompute.com

THE CHALLENGE

To make High Performance CFRP economically viable for large scale production, it is essential to reduce overall development and production costs. The big advantage of a continuous virtual CAE chain would be the acceleration of the development loops. The objective of this experiment was to develop a CAE chain which could reduce the overall development and production costs through the implementation of the associated development loops.

THE SOLUTION

KIT, the domain expert, working with Fraunhofer SCAI, has developed a prototype simulation platform which allows the user to plan manufacturing processes and predict the final structural performance of a material. An integrated workflow to optimise the design of CFRP components has been developed, which uses the prototype from KIT and Fraunhofer SCAI. It is accessible through a web based interface and runs on a Cloud-based HPC system at Gompute, which can easily satisfy the necessary compute requirements.

BUSINESS IMPACT

The platform developed here increases the quality of design of composite materials, adds functionality, and reduces the engineer's work load. It shortens simulation times from days to hours whilst offering more detailed simulations. Using simulation leads to less material usage, due to the reduced need for physical prototyping and mechanical testing. Formtech has already exploited the HPC capacity of Gompute to meet a project deadline where a 50% reduction in compute time was imperative, so using advanced simulation has enabled Formtech to maintain a competitive edge over other companies world-wide. As a result of using advanced simulation, Formtech anticipates an increase in revenue per annum of ~€100.000. KIT estimates that, due to time saving through using HPC systems, it will increase its annual revenues by around €30.000. Additionally, annual personnel costs will be reduced by €10.000. Fraunhofer SCAI expects a strongly growing demand for customised and integrated CAE development. Fraunhofer SCAI estimates that, during the next 2 to 3 years, it can increase its regular annual licence revenues by ~€60.000. The outcome of this experiment has given valuable feedback to Gompute. The success of this CAE chain implementation has already brought new business with annual turnovers of over €2.000 for the sale of compute cycles. KIT and Fraunhofer SCAI plan to offer a CFRP simulation service via the Fortissimo Marketplace starting in Q3 2017.

BENEFITS

- Increases quality of designs, added functionality and reduced workload on engineer's side due to developed platform.
- Shorter simulation times from days to hours.
- Less material usage and fewer mechanical tests.

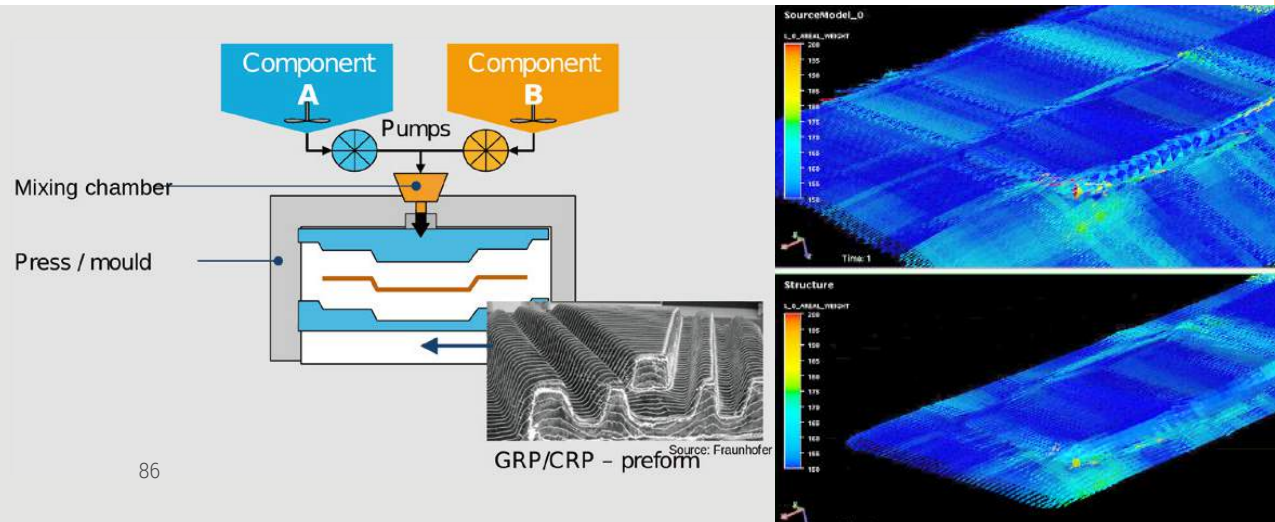

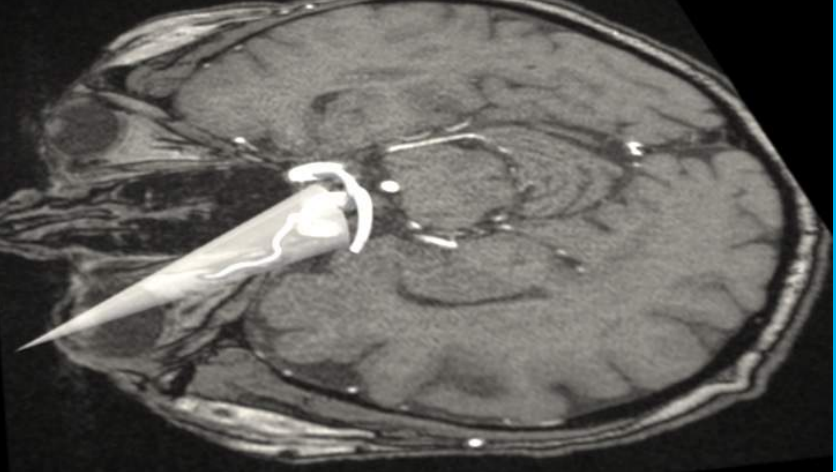

EXPERIMENT #603 HIGHLIGHTS

Industry Sector: **Health**

Country: **Lithuania**

Software used: **In house code**

Cerebral blood-flow simulations



ORGANIZATIONS

The non-invasive accurate and quick measurement of the intracranial pressure (ICP) is of paramount importance for the diagnosis and treatment of neurological diseases, brain injuries and other neuro-pathologies. The world's first accurate, non-invasive ICP measurement device, based on two-depth ultrasound Doppler technology, has been developed by a Lithuanian SME, Vittamed. The Simula Research Laboratory was founded in Norway in 2001. Its main objective is to create knowledge about fundamental scientific challenges of genuine value for society. Simula has developed leading-edge blood flow models. The use of these models in the simulation of ICP requires the use of HPC. The implementation of these models on a Cloud-based HPC system is the objective of this experiment.



THE CHALLENGE

The challenge facing the partners in this experiment was to create mathematical models and develop the necessary software tools to enable simulations of cerebral blood flow in the ophthalmic artery. The computational requirements of this made it necessary to adapt the software tools to run on an HPC system. The goal was to demonstrate the feasibility and benefits of such simulations via a pay-per-use Cloud-based HPC solution.

THE SOLUTION

An internal Carotid/Ophthalmic Artery model has been developed, based on MRI imaging, and used to simulate blood flow. This model has been tested and optimised to run on a multi-processor HPC system. It will be used by Vittamed in the future development of its non-invasive ICP measurement technology. Simula has written and tested the necessary software tools needed to implement the required simulations. These tools enable the efficient implementation of the model on an HPC system.

BUSINESS IMPACT

Vittamed can now reduce their time to market due to shorter simulation times. This will also allow them to design more accurate products based on blood flow simulations - Vittamed is targeting entry to the ophthalmological market for glaucoma diagnostics, where more precise and accurate ICP measurements are needed. In glaucoma management, improved measurements of intraocular and intracranial pressure would enable the development of innovative screening technologies and treatment methods. Vittamed can gain a significant commercial benefit resulting from the global expansion of the market for ICP diagnostic devices in ophthalmology. The global market for ophthalmic diagnostic equipment is estimated to reach \$947M in 2017. The new market niche for SME in ophthalmology will create a commercial opportunity with an estimated potential of more than €100 million per year. Simula Research Laboratory will exploit the results of this experiment by developing research projects with industrial, clinical, and scientific communities across Europe and beyond. The open-source solver developed is an attractive alternative to commercial solvers because there are no associated licence fees. The results of the experiment will support the HPC Cloud provider, CINECA, in offering its services to the biomedical market, enabling SMEs to benefit from HPC-based simulation.

BENEFITS

- Shorter simulation time.
- Design more accurate products based on blood flow simulations.
- Development research projects with industrial, clinical and scientific communities.

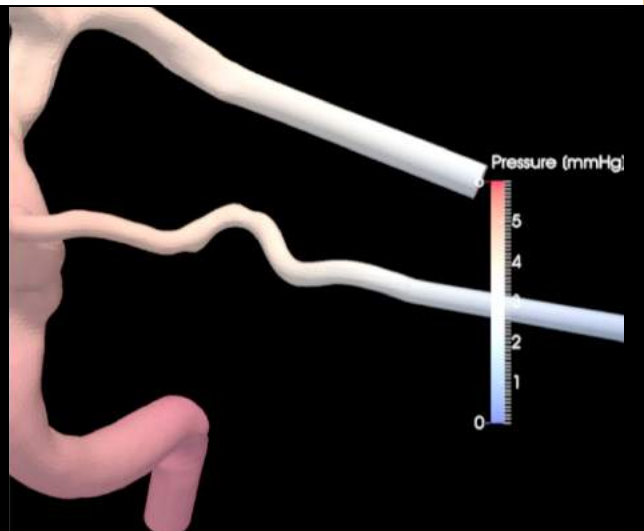
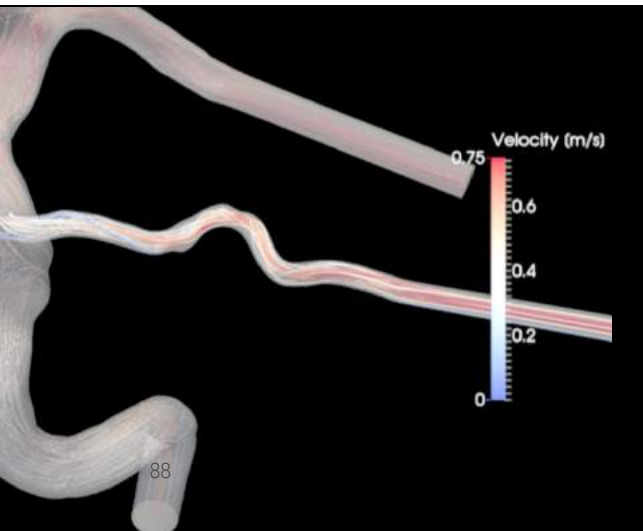



Cloud-based simulation of complex fluids



ORGANIZATIONS

Ioniqa, a Dutch SME, specialises in the development of MSMs (Magnetic Smart Materials) used in various mechanical, chemical processes and a range of applications including automotive and seismic shock absorbers. Ioniqa has developed a PET-recycling process involving MSMs to degrade coloured PET waste into 'virgin quality' raw materials, competing with oil-based PET in both quality and costs. With this game changing technology Ioniqa has found a profitable solution for almost a quarter of all plastic waste in the world. The modelling of Magnetic Smart Materials and Processes is very demanding involving the simulation of the microstructure of complex fluids and its effect on transport and rheology. Electric Ant Lab, a Dutch SME, has developed a software package called SuSi which allows to perform such simulations.

End User



www.ioniqa.com

ISV



www.electricant.com

HPC Expert & Provider



www.surfsara.nl

THE CHALLENGE

Electric Ant Lab (EAL) has developed HPC software for the detailed simulation of complex fluids. The high-fidelity simulation of an MSM, as needed by Ioniqa, requires a resolution of smaller than 1µm in space and 0.1µs in time. Simulations of a material sample of 1mm³ and a physical time span of 1 second with this resolution would take around 10 years on a single CPU-core. State-of-the-art HPC resources with high-end GPGPU accelerators are required to bring the total runtime of complex-fluid simulations down to an acceptable timescale of 1 or 2 days.

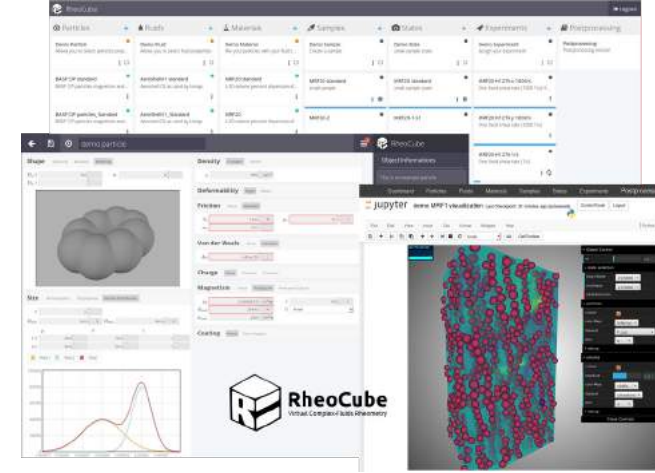
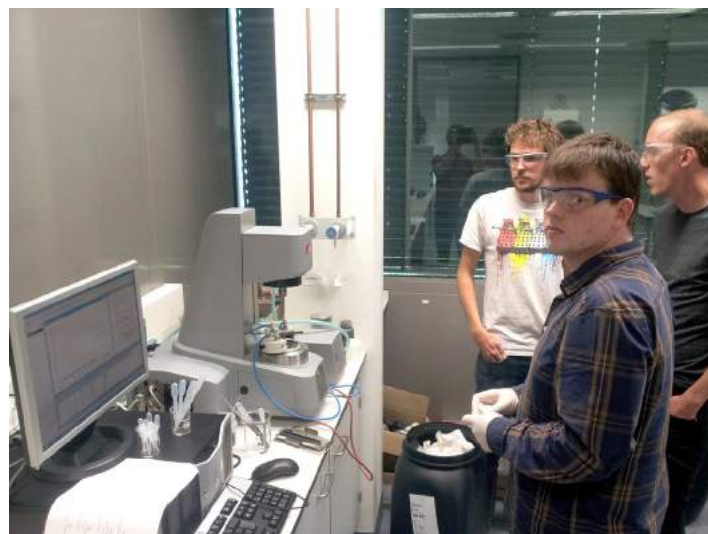
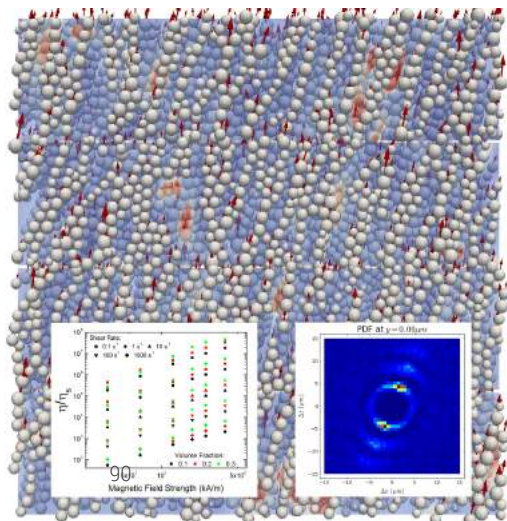

THE SOLUTION

A user interface has been developed within the RheoCube environment, which emulates a "wet lab" familiar to material scientists. It provides a workflow that enables the user to design materials and run experiments on the HPC Cloud backend. Objects such as materials, samples, states and experiments can be intuitively managed and shared with other project members. Data analysis and visualisation tools have been integrated in the Cloud-based post-processing supporting the interpretation of simulation results by the user.

BUSINESS IMPACT

RheoCube as a virtual complex-fluids rheometry solution has the proven potential to significantly reduce R&D costs and time-to-market for complex-fluids and smart material products. With lab researchers as users in mind the total addressable market has a size of €2 billion.

As a result of this experiment, RheoCube can be offered as a SaaS (Software-as-a-Service), making high-fidelity simulations of complex fluids available to SMEs in an affordable way, thus giving them a valuable tool for material innovation. Using RheoCube, Ioniqa is able to reduce the costs of their MSM development by up to 90%.

EAL estimates a total net profit of ~€400.000 over the next five years based on income from consulting and providing RheoCube as an SaaS, leading to a yearly profit of ~€550.000 from 2022 onwards.

As resource provider for RheoCube, SURFsara has a projected revenue stream of ~€13.000 in 2017 with a doubling of revenue each year for the following 4 years.

Both, RheoCube and EAL's consultancy on HPC simulations of complex fluids and smart materials will be offered through the Fortissimo Marketplace.

EXPERIMENT #604 HIGHLIGHTS

Industry Sector: **Manufacturing**
Country: **Netherlands**
Software used: **RheoCube, SuSi**

BENEFITS

- EAL estimates a total net profit of ~€400.000 over the next five years based on income from consulting and the provision of RheoCube as an SaaS.
- SURFsara has a projected revenue stream through its collaboration with Electric Ant Lab of ~€13.000 in 2017 with a doubling of revenue each year for the following 4 years.
- Both, RheoCube and EAL's consultancy will be offered through the Fortissimo Marketplace.



HPC Cloud-based seakeeping design

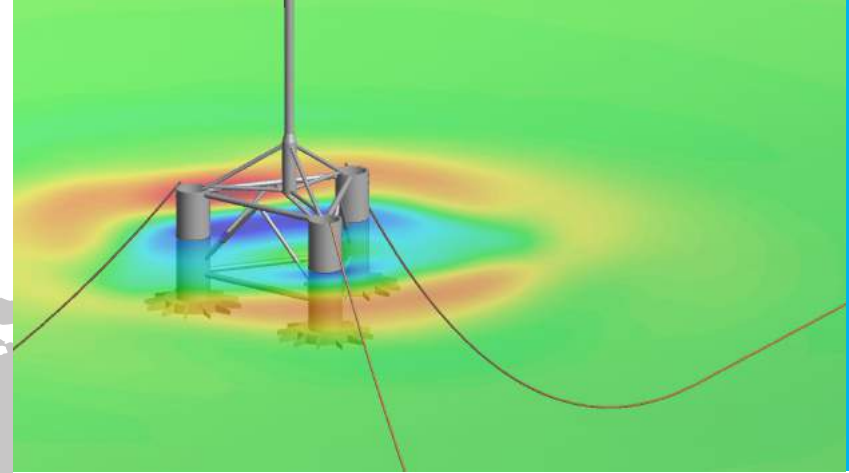

EXPERIMENT #605 HIGHLIGHTS

Industry Sector:
Maritime

Country:
Portugal & Spain

Software used:
SeaFEM, In house code XFire

ORGANIZATIONS

Seakeeping is the study of a ship or marine structure that is subject to the action of waves. WAVEC is a private non-profit association active in applied research and consulting. VICUSDT operates in the shipbuilding and shipping industries, providing hydrodynamic engineering services. It also provides hydrodynamic analysis capabilities to the offshore and marine energy sector, carrying out advanced simulations of structures for the oil and gas industry. COMPASSIS is an SME ISV which provides simulation software for a variety of different engineering fields including multiphysics simulations and structural and seakeeping analysis. CIMNE, a research organisation, will also provide some of the software components required for this simulation.



End User	ISV	Domain Expert	HPC Provider
 www.wavec.org	 www.vicusdt.com	 www.compassis.com	 www.cesga.es
		 www.cimne.com	

THE CHALLENGE

The challenge addressed in this experiment was demonstrate how advanced computing can optimise seakeeping design. Seakeeping simulations are large and complex, and so require significant compute power to be completed in a reasonable time. To achieve this, existing seakeeping software would need to be adapted to run on remote HPC resources. This would give WAVEC and VICUSDT a powerful design tool and a significant competitive advantage.

THE SOLUTION

The relevant software packages have been ported to the HPC Cloud-based system and integrated into an overall simulation package. An interface between the end user and the HPC resources has been implemented, so simulations can be run from a familiar desktop system whilst using the full capabilities of the HPC system. The simulations have been benchmarked using a model of an off-shore floating wind platform and a model of a stern trawler, which showed a speed-up by a factor of 45 on the HPC system.

BUSINESS IMPACT

The use of Cloud-based HPC simulations enables cases to be analysed far more quickly than was previously possible. Due to the speed up in calculation time, it also allows previously infeasible cases to be analysed, and solutions devised. The ability to take on seakeeping cases that other companies cannot gives WAVEC and VICUSDT a significant competitive advantage in the sector. HPC Cloud-based simulation of marine structures has the potential to expand WAVEC's activities as a consulting company specialized in services for the offshore renewable industry and other related industries (aquaculture, oil and gas). Over the next four years, from 2017 to 2020, WAVEC expects an increase in its total profit of ~€550.000, based on a revenue of €1,8 million, due to an increase in its consultancy activities. Over the same four-year period, VICUSDT expects an increase in its total profit of €480.000, based on a revenue of €1,4 million, due to an increase in its consultancy activities. Over the same four year period, COMPASSIS expects an increase in profit of €2 million based on an increase in its licence sales of €4,5 million. A service for seakeeping assessments based on the results of this experiment is planned to be available in the Fortissimo Marketplace. Furthermore, CESGA proposes to offer a service in the Marketplace bases on the benchmarking of key applications and their performance and scalability.

BENEFITS

- Due to speed up in calculation time, it also allows previously infeasible cases can be analysed and solutions devised.
- Over the next four years WavEC and VICUSdt expect a notable increase in its total profit based on a revenue due to an increase in its consultancy activities.

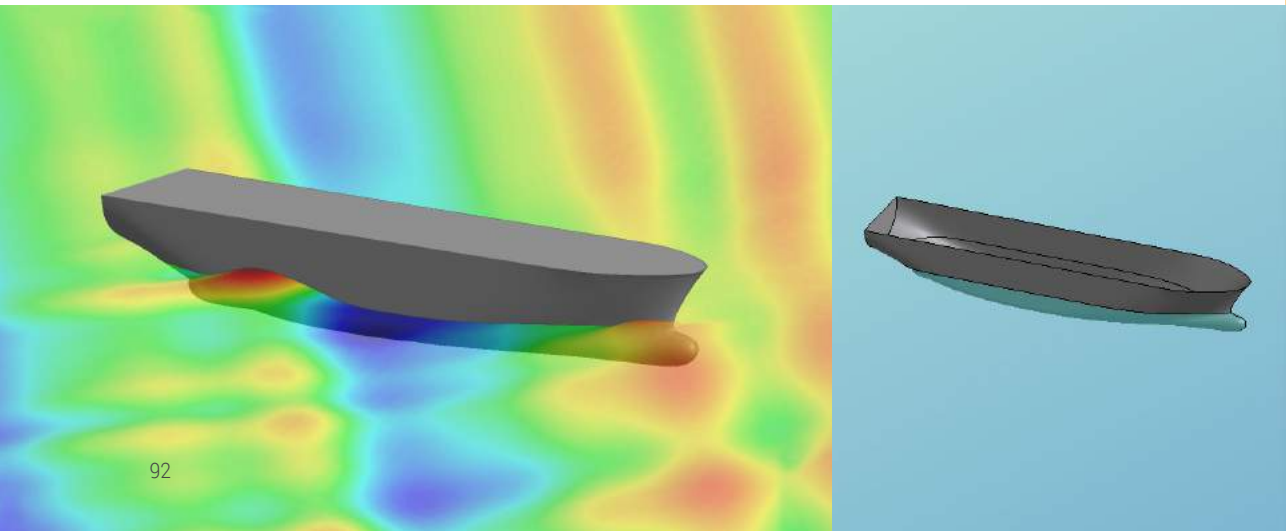



HPC Cloud-based standard strength assessment of commercial ships

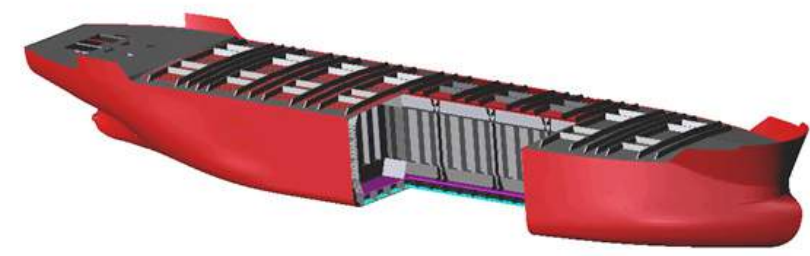

EXPERIMENT #606 HIGHLIGHTS

Industry Sector: **Maritime**

Country: **Spain**

Software used: **RamSeries**

ORGANIZATIONS

ISONAVAL, an SME working in the areas of naval architecture and marine engineering services, is specialized in the generation of analysis and production information for ships, yachts and naval artefacts. Merchant ships (such as tankers and container ships) must undergo a standard strength assessment as a statutory requirement, and advanced simulation could be useful in standard strength assessment calculations. COMPASSIS is an SME ISV which markets simulation software, RamSeries, in different engineering fields including multiphysics simulations and structural analysis. In this experiment the expertise and software of COMPASSIS will be complemented by FNB-UPC, a University research centre developing innovative simulation tools and implementing them on HPC systems.



THE CHALLENGE

The challenge addressed in this experiment was to demonstrate the use of advanced simulation in standard strength assessments of merchant ships. Large amounts of computing power are required to complete these simulations in a reasonable time. The objective here was to adapt standard strength assessment software, RamSeries, to run on remote HPC resources, and demonstrate the benefits of advanced simulation using Cloud-based HPC for this purpose.

THE SOLUTION

The relevant software packages, including RamSeries, have been ported to an HPC Cloud-based system and integrated into an overall simulation package. An effective interface between the end user and the HPC resources has been implemented which integrates the various software components and the HPC system. The simulations have been benchmarked using a model of the full 3D hull structure of a merchant ship. These demonstrated a significant speed-up by a factor of 42 through the use of an HPC system.

BUSINESS IMPACT

A standard strength assessment study of a tanker requires more than a week on a desktop system. Using RamSeries with HPC resources reduces this time to less than 6 hours. This significantly reduced compute time fits much better to the design cycle of companies. COMPASSIS will increase its market by introducing the use of the RamSeries software for the direct strength assessment of a complete ship structure. This assessment requires large computational and data storage resources. COMPASSIS estimates an additional annual revenue of €24.000 in 2017 growing to €120.000 in 2020, due to the sale of direct strength assessment of complete ship structures using RamSeries integrated with a Fortissimo HPC infrastructure. ISONAVAL estimates an additional annual revenue of €15.000 in 2017 growing to €60.000 in 2020, also due to the sale of direct strength assessment of complete ship structures. CESGA will offer new HPC added-value services for SMEs such as benchmarking to analyse performance of HPC applications, including multi-core scalability and its dependency on different parameters such as size of the problem and processor frequency. It expects a consequent increase in its HPC services and customers. New alliances with ISV and application experts have been formed during this experiment. Revenues based on 3 benchmarking studies and an annual fee for hosting the ISV software and for infrastructure maintenance will be around €35.000 over a 4-year period.

BENEFITS

- Significantly reduced computation time.
- Increased market, for Compassis, by introducing the use of RamSeries software.
- Additional annual revenue for end user ISONAVAL, due to the sale of direct strength assessment of complete ship structures.

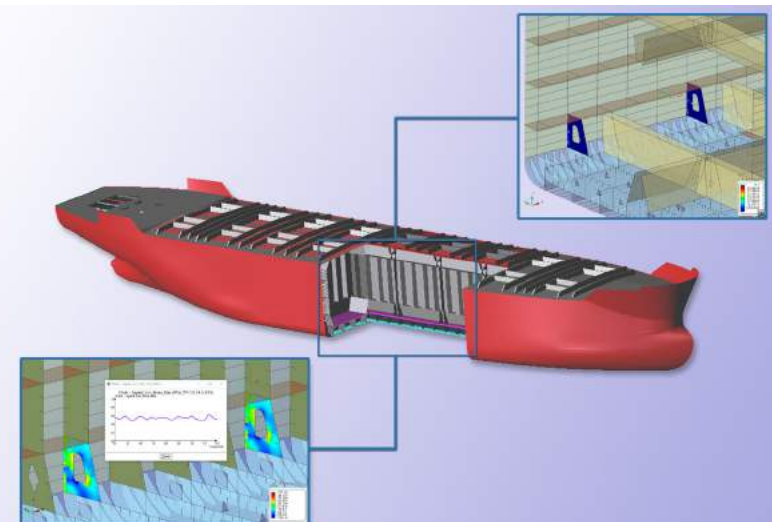



Cloud-based shape optimisation in manufacturing

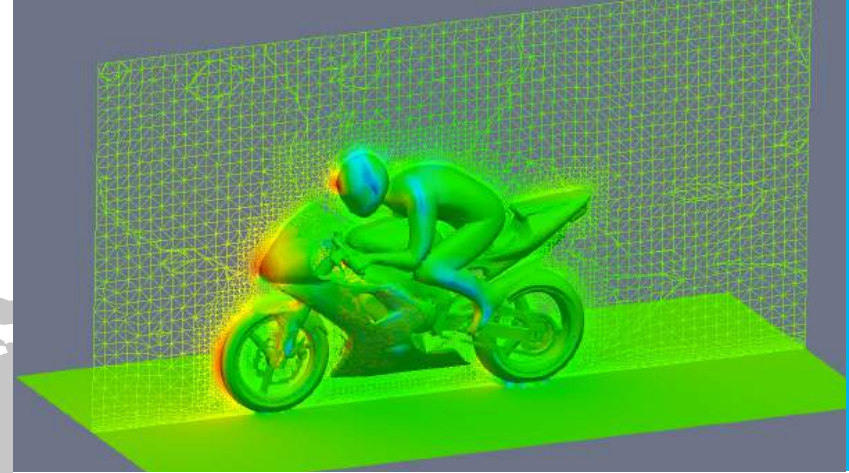

EXPERIMENT #607 HIGHLIGHTS
Industry Sector: **Automotive**
Country: **Italy**
Software used: **Camilo**

ORGANIZATIONS

Automobili Lamborghini is an Italian manufacturer of luxury sports cars and SUVs. Founded in 2006, OPTIMAD is an Italian SME active in shape and topology optimisation in the engineering sector. The objective of this experiment was to demonstrate that by combining High Performance Computing (HPC) and optimisation software, there is an opportunity to change current design practices and bring automatic shape optimisation (ASO) to a wider audience of manufacturing SMEs. The goal was to develop and implement an HPC Cloud-based platform that gave the inexperienced user the possibility to optimise automatically the shape of a particular mechanical system. The aim was to test this solution using practical test cases from the end-user Lamborghini.

End User	ISV	Application Expert	HPC Provider
www.lamborghini.com	www.optimad.it	www.strath.ac.uk	www.cineca.it

THE CHALLENGE

There are several issues associated to the use of automatic shape optimization. It takes significant computational power, because many simulations need to be evaluated, and only specialised engineers can set up a viable ASO procedure. The challenge facing this experiment was therefore to develop a platform which combined Cloud-based HPC resources with in-house computing capabilities, and develop an intuitive user interface for non-expert users.

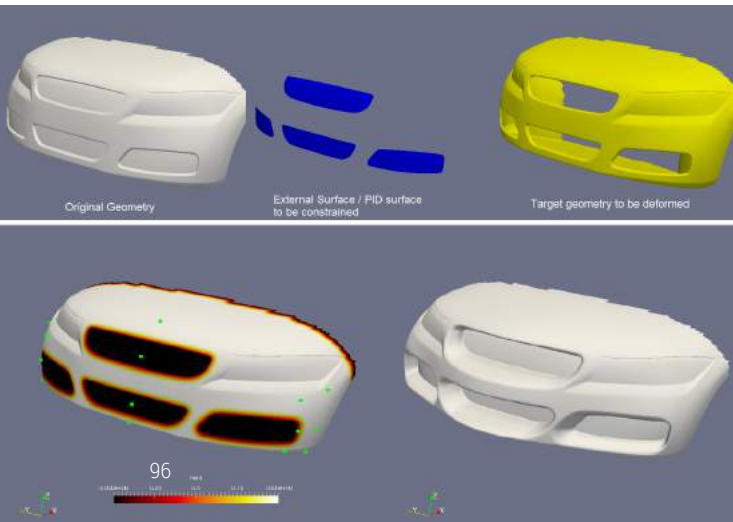

THE SOLUTION

The SOUTH platform has been developed. This provides an integrated environment with access to optimization software and both in-house and Cloud-based HPC computing resources. There is a high degree of automation, but users can interact with the optimisation process and investigate partial solutions. Users experienced in simulation but inexperienced in optimization can easily set up runs. This is an innovative and cost-effective approach to making shape-optimisation software available to SMEs.

BUSINESS IMPACT

Lamborghini has its own HPC resources, but having its environment duplicated by a supercomputing-class HPC centre has several benefits. These include a reduction in development time of 40%, and the ability to dealing with peaks in the demand for computer resources by using Cloud-based HPC. The use of SOUTH reduces the effort for a typical optimisation from 2,25 person months to 2,0 days and the simulation time from 3 months to less than 10 days. Although the number of CPU hours required rises from 120.000 to 160.000, the overall reduction in cost is ~ €18.000. Generally, considering the average design activity in the company, yearly cost savings are expected to range from €140.000 to €200.000. Until now, OPTIMAD has provided automatic shape optimization mainly as a consultancy service with typical cost to the end user of ~ €20.000 to €40.000 per optimisation. Through the SOUTH platform, the same service may be delivered with typical costs of ~ €8.000 to €12.000 whilst keeping the same profit margins. This will permit OPTIMAD to offer a more competitive and attractive service to the market. It is estimated that in the first year through the use of SOUTH in its consultancy service, the increase in revenue for OPTIMAD will be ~ €75.000 with a net profit of ~ €22.000. By deploying SOUTH as a scalable SaaS using Cloud-based HPC resources, OPTIMAD expects further revenues in the first year of operation to be €150.000 with a net profit of €37.000.

BENEFITS

- Reduction in development time of 40%.
- Reduction of simulation time from 3 months to 10 days.



HPC Cloud-based microscopy

ORGANIZATIONS

MicroscopeIT is a Polish technology-based SME company, founded in 2012, which has introduced an internet service called VIRTUM. VIRTUM provides computations in a Software-as-a-Service (SaaS) model for use in microscopy. Before this experiment, VIRTUM comprised a client-server architecture using in-house computer resources. UZH is a University laboratory making significant use of microscopic data. In this experiment UZH provided a test case in the area of fluorescent microscopy. OpTecBB is the competence network for optical technologies and micro-system technology in the region of Berlin-Brandenburg.

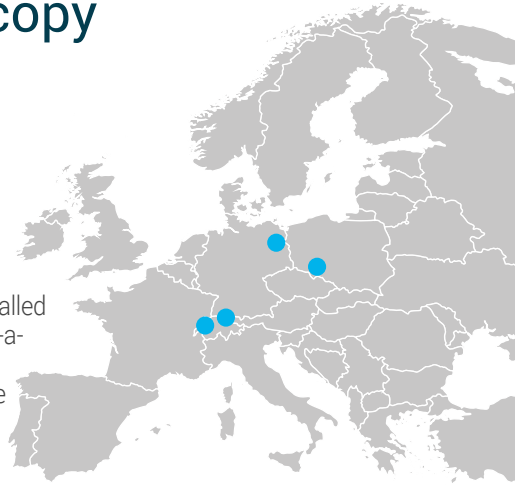

End User

ISV

HPC Provider & Expert

Hardware Vendor

University of Zurich
OpTecBB
Nikon

www.interfacegroup.ch
www.optecbb.de
www.nikon.com

MICROSCOPE IT

www.microscopeit.com

ARCTUR

www.arctur.si

OPTA-TECH

www.opta-tech.com

THE CHALLENGE

The challenge here was to adapt the VIRTUM service to an HPC Cloud-based infrastructure and to test the new service on four numerically intensive test cases. The test cases were: analysis of images from remotely controlled fluorescence microscopy; processing data from super-resolution microscopy; management and visualization of spectroscopic data; and whole slide imaging and analysis in digital pathology and high-throughput screening.

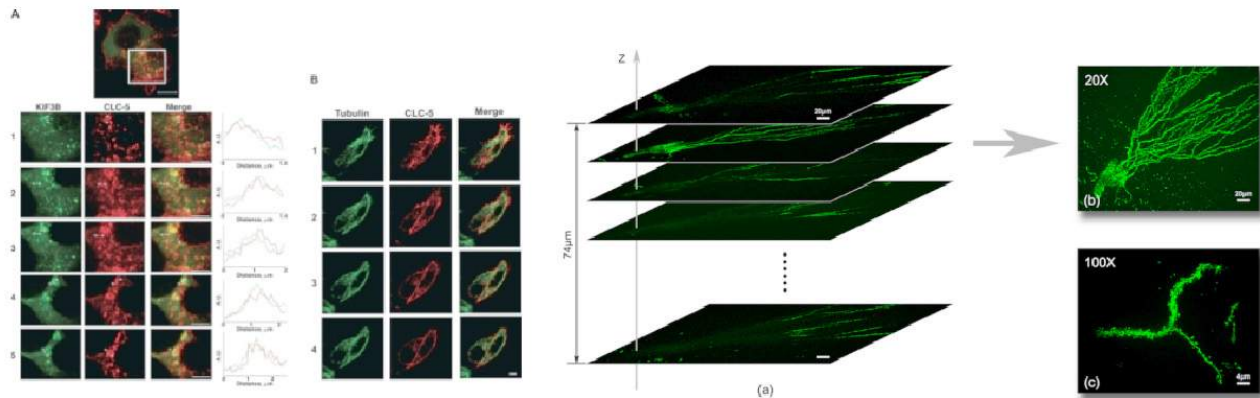

EXPERIMENT #608 HIGHLIGHTS

Industry Sector:
Health

Country: **Poland, Switzerland & Germany**

Software used:
In house code

THE SOLUTION

The VIRTUM service has been adapted to work on an external Cloud-based HPC infrastructure. Through the use of HPC, the time taken to process test cases has been reduced from one day to a few hours, a typical reduction of 5 times. A cross-platform, simple user-interface has also been developed. This supports the visualisation of data and its management from almost any device. Furthermore, the VIRTUM service provides flexible licensing models allowing end users to optimize their costs.

BUSINESS IMPACT

Clinical laboratories and R&D departments produce and analyse huge amounts of microscopic image data. This is used in medical diagnosis, to accelerate drug discovery, and for biomedical research. To support the analysis of this data, there is a significant SME-based industry for the manufacturing of microscopes and spectrometers serving the biotech and material science industries. In many cases the analysis of this data can be computationally intensive requiring the use of powerful computers. In this experiment, the expertise and software of MicroscopeIT has been complemented by the end user requirements of UZH and OpTecBB and the HPC expertise of Arctur. This has greatly enhanced VIRTUM's availability, capabilities and affordability, particularly to SMEs. VIRTUM-DP has the potential to remove obstacles and bottlenecks in current oncological diagnostics. Its main benefit is a significant improvement in clinical diagnosis. This is due to the increased speed and quality of diagnosis, an increased throughput of diagnoses, and more accessible storage of samples. VIRTUM-DP can result in a reduction in staff costs by 50% through increased efficiency, which in the USA alone results in an overall saving per annum of \$1,7 billion. Furthermore, there is a significant cost saving in IT infrastructure through the use of Cloud-based processing as in most cases, computer resources available via the Cloud are more cost-effective.

BENEFITS

- High cost savings in the IT infrastructure are possible due to Cloud-based processing that is more cost-effective.
- Reduction in staff costs by 50% through increased efficiency.
- The time taken to process test cases has been reduced by 5 times, from one day to a few hours.



HPC based Delft3D service for modelling flooding, morphology, and water quality

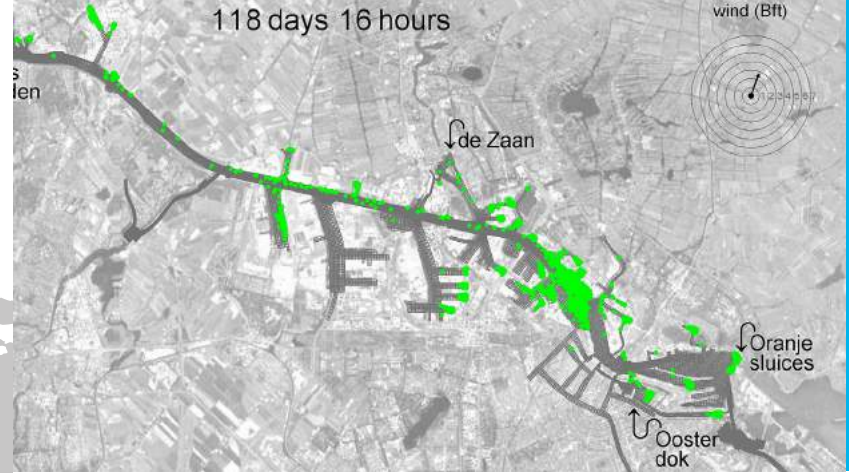

EXPERIMENT #610 HIGHLIGHTS
Industry Sector: **Civil Engineering**
Country: **Netherlands**
Software used: **Delft3D**

ORGANIZATIONS

Deltares is an independent non-profit institute for applied research in the field of water and subsurface. They have five areas of expertise: flood risk, environment, water and subsoil resources, delta infrastructure, and adaptive delta planning. They have developed a modelling suite, Delft3D, to tackle their challenges. One of the SMEs that use Delft3D is HKV Consultants. They provide consultancy services and conduct research in the fields of safety, drought and flood risk analyses for rivers, coasts, estuaries and urban water systems. Its clients include private businesses, governments, research institutes, and regional water authorities worldwide. For their consultancy services and research, at the moment, HKV runs Delft3D on local desktop machines and clusters.



End User	Domain Expert & ISV	HPC Expert & Provider
www.hkvconsultants.com	www.deltares.nl	www.surfsara.nl

THE CHALLENGE

Delft3D has been open source since 2011 and is used worldwide. It consists of modules for modelling hydrodynamics, waves, morphology, water quality, and ecology. However, to improve the quality of its work, HKV needed easy access to a version of Delft3D that could scale to available hardware resources in a flexible way. The objective was to develop a pilot version of Delft3D-as-a-Service (DaaS) that could run for remote use by HKV.

BUSINESS IMPACT

DaaS opens new possibilities for SMEs such as HKV, because it offers quick, efficient, and flexible access to HPC hardware resources for modelling and simulation using Delft3D. This Fortissimo experiment served as a starting point for gradual transition for current Delft3D users and growth model for new Delft3D users worldwide. Deltares and HKV themselves are already involved in further projects using Delft3D running on remote HPC systems. Deltares expects additional revenues of about €70.000 per annum due to an increase in the use of (certified) Delft3D and of about €500.000 per annum due to an increase in Delft3D-related advisory and research projects by Deltares itself. With DaaS, Deltares expects an increase of business opportunities in data and forecasting services based on Delft3D and projects related to large scale computing with Delft3D, for example for dike safety assessments. Due to the new possibilities of DaaS for large ensemble modelling and highly detailed modeling, HKV expects additional revenues of about €100.000 and €30.000 per annum, respectively. With DaaS, HKV expects an increase of business opportunities in add-on services based on Delft3D. Furthermore, DaaS will reduce risks in projects with a lot of Delft3D modelling, with the opportunity to spend more project time on creating added value for the client.

BENEFITS

- End user expects additional revenues of about €70.000 per annum due to an increase in the use of (certified) Delft3D and of about €500.000 per annum due to an increase in Delft3D - related advisory and research projects.
- With DaaS, the end user expects an increase of business opportunities in data and forecasting services.
- HKV expects additional revenues of about €100.000 and €30.000 per annum.

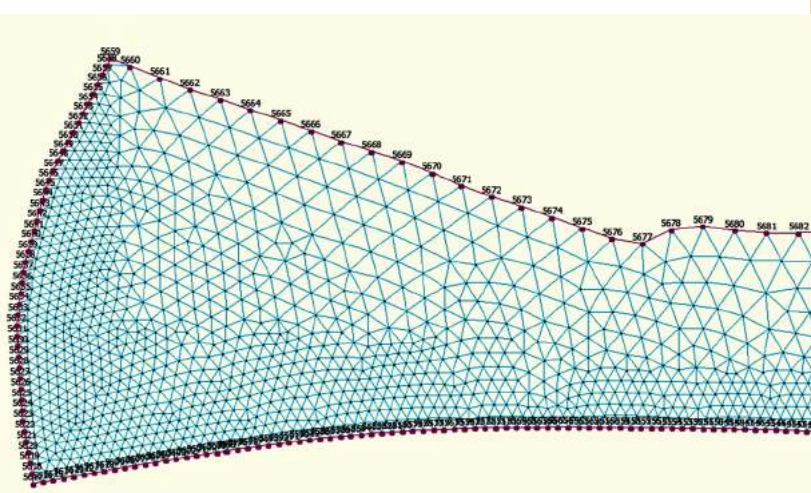
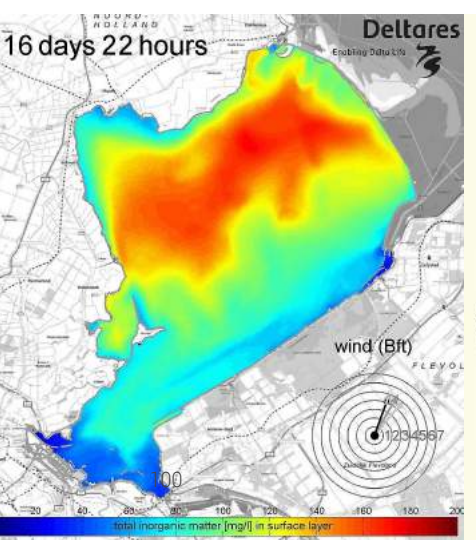

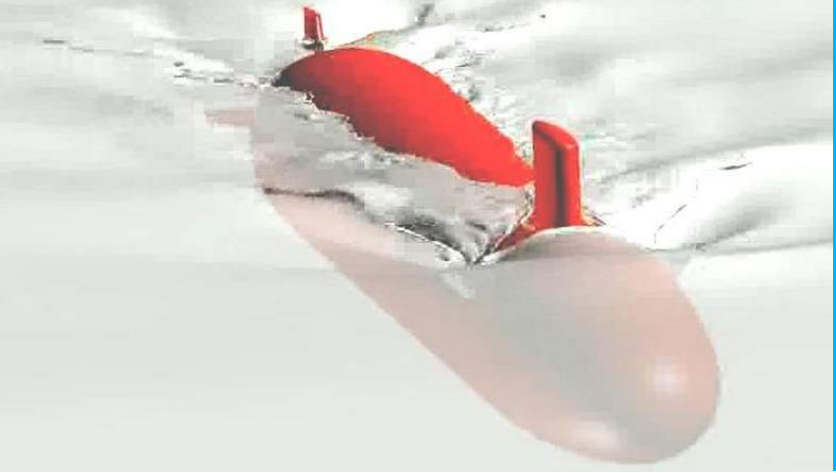

EXPERIMENT #611 HIGHLIGHTS

Industry Sector: **Maritime**

Country: **France**

Software used: **K-FSI**

Cloud-based simulation of marine communication buoys



ORGANIZATIONS

ALSEAMAR is a French SME, specialised in the design and manufacturing of radio communication systems for both surface ships and submarines. ALSEAMAR wanted to develop a releasable, communication buoy for submarines. This experiment aimed to design such a device using HPC-based CFD. K-Epsilon is a French SME which offers CFD consulting and the development of customised software. In particular K-Epsilon develops and markets the software package K-FSI which formed the basis for the simulation model used in this experiment. In addition to this, the role of K-Epsilon in this experiment was to support the partners in the simulation of a releasable communication buoy, using Cloud-based HPC, and to demonstrate the benefits of advanced CFD simulations.

End User	Application Expert & ISV	HPC Expert & Provider
www.alseamar-alcen.com	www.k-epsilon.com	www.bull.com

THE CHALLENGE

ALSEAMAR needs to investigate the behaviour of a radio communication buoy released from a submarine. Numerical simulation is the only way to do this, because tests involving real submarines are almost impossible. This type of simulation involves a strong fluid structure interaction coupling and the use of large and fine overset meshes. Computations are required to run for multiple days to converge. To compute these cases in a reasonable timeframe, simulation software must necessarily be run on an HPC system.

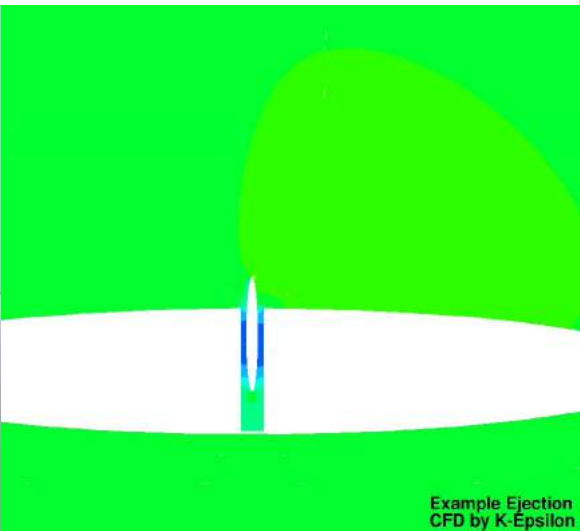
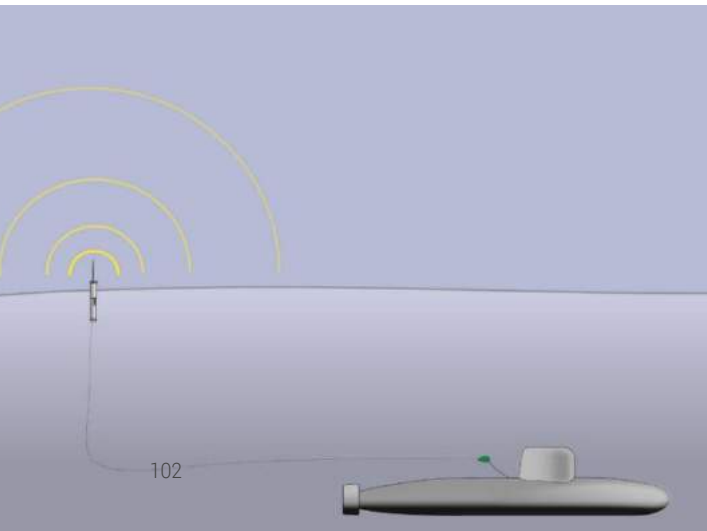

Example Ejection CFD by K-Epsilon

THE SOLUTION

K-FSI and FINE™/Marine (Numeca) software has been ported to the BULL eXtreme factory HPC-as-a-Service, to create an appropriate simulation model. An online solution monitor has been integrated with the eXtreme factory web interface. Because end users such as ALSEAMAR do not possess the skills to perform simulations of such complex cases, K-Epsilon makes use of the pay-per-use HPC Cloud on their behalf. Specific workflows have been developed to reduce engineering time and to feed into the ALSEAMAR design cycle.

BUSINESS IMPACT

Computational Fluid Dynamics (CFD) has demonstrated its ability to model detailed scenarios with great robustness. However, some complex applications are still challenging. For such applications, HPC is required to perform the required computations in a reasonable timeframe. In this experiment, ALSEAMAR has developed a releasable communication buoy for submarines. The resultant revenue is estimated to be €500.000 in 2017 and €1 million in 2018. ALSEAMAR estimates that 3 jobs will result and its turnover will increase by 20%. These figures are based on the sale of 125 units in 2017 and 250 in 2018. Through this experiment, ALSEAMAR has gained confidence in using CFD simulations to improve their design process, offering an alternative to physical tests. This experiment enabled K-Epsilon to integrate its in-house tool K-FSI on a HPC Cloud, with a pay-per-use service. The results have demonstrated the capabilities of K-Epsilon to address very complex cases with K-FSI. 2 jobs were created during the Fortissimo project, and K-Epsilon expects to create another 3 positions in a five-year plan. K-Epsilon's annual turnover is expected to increase by 8% in 2017, and by 65% over the next five years. For Bull, this experiment has been an opportunity to reach new potential customers in the maritime market. Bull will earn 20% of the turnover from simulations by K-Epsilon, through the provision of cycles via eXtreme Factory.

BENEFITS

- Two new jobs positions were created during the Fortissimo project, and K-Epsilon expects to create another three positions in a five-year plan.
- K-Epsilon's annual turnover is expected to increase by 65% over the next 5 years.
- Bull will earn 20% of the turnover from simulations by K-Epsilon, through the provision of cycles via eXtreme Factory.



Cloud-based simulation for vehicle engineering

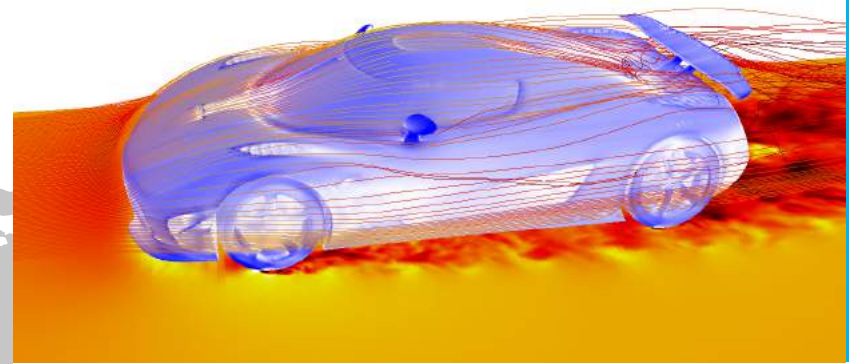

EXPERIMENT #701 HIGHLIGHTS

Industry Sector: **Automotive**

Country: **Sweden**

Software used: **iconCFD®**



ORGANIZATIONS

Koenigsegg Automotive AB is a Swedish SME whose core business is the development and production of high-performance, high-quality, limited-edition motor vehicles – so called hyper-cars. ICON Technology & Process Consulting (ICON) is a UK head-quartered company which specialises in the delivery of advanced Computation Fluid Dynamics (CFD) products and related services for industry.

End User



www.koenigsegg.com

HPC Expert & Provider



www.epcc.ed.ac.uk

ISV



www.iconcfid.com

THE CHALLENGE

Analysing how air flows around a vehicle is essential to making it faster and more efficient. Physical testing is expensive due to the costs of models and test facilities. Computer simulation removes the need for these, and enables the engineers to make changes to the design more easily. However, simulating airflow with the required degree of accuracy requires computing power beyond the reach of most designers, mainly due to the capital costs of the equipment.

BUSINESS IMPACT

Obtaining an in-house capability for rotating wheel aerodynamic simulation requires an initial investment of €200.000 - €300.000 including hardware, and software licences allowing approximately 50 simulations per year. In addition, an annual maintenance and operational cost of approximately €100.000 including hardware warranties, electricity, software licences, etc. is required. This is a prohibitive cost for SMEs.

In comparison, a streamlined process accessed on-line and benefitting from on-demand HPC and ISV expertise could cost as low as €900 per simulation to the end user, therefore making high-end simulation affordable to SMEs. This can reduce or even eliminate the need for physical testing, saving further time and money on models and wind tunnels.

The experience of Koenigsegg is that around €100.000 can be saved annually on design costs by using this technology that was previously only affordable to large companies.

For ICON, the apps they have developed will allow them to offer their services to new clients in the automotive SME sector.

BENEFITS

- €100.000 annual saving on design costs – saving 30% over previous solutions.
- High-end simulations for as little as €900 per simulation.
- No need for SME to purchase expensive equipment.
- Significant time saving as there is no need for physical testing.

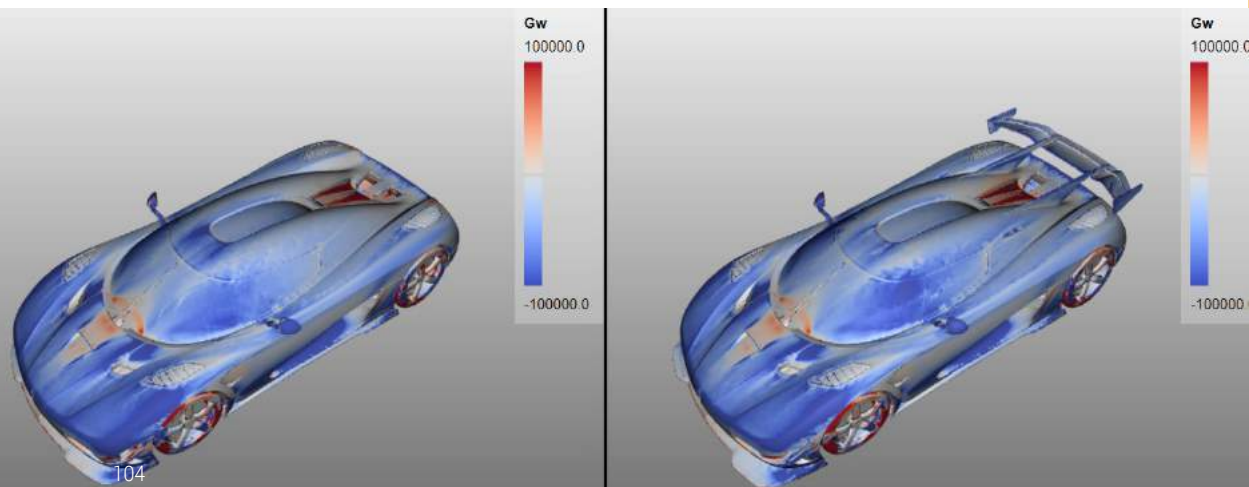



Optimising gas and flame detector layouts in hazardous manufacturing and production plants

ORGANIZATIONS

Micropack is a British SME which designs, manufactures and installs its own range of detectors for use in fire and gas safety. It also consults on fire and gas safety design and gas dispersion. Gexcon AS is a Norwegian company and the market leader in dispersion, fire and explosion modelling software for hazardous production areas. Gexcon develops the multi-physics modelling application FLACS, a simulation tool used worldwide for safety studies.



End User



www.micropack.co.uk

HPC Expert & Provider



www.epcc.ed.ac.uk

ISV



www.gexcon.com

THE CHALLENGE

Gas detectors are commonly installed in manufacturing and production facilities where hazardous substances are processed (such as oil and gas installations), to automatically alarm and trigger safety measures in response to leak events. Gexcon, the software provider, produces FLACS, a CFD modelling software used for safety studies. To date, the amount of computing power required for a CFD-based optimisation of gas detector layouts has been prohibitive in terms of both costs and time. Gexcon and Micropack joined forces to develop the next-generation methodology for gas detection system design.

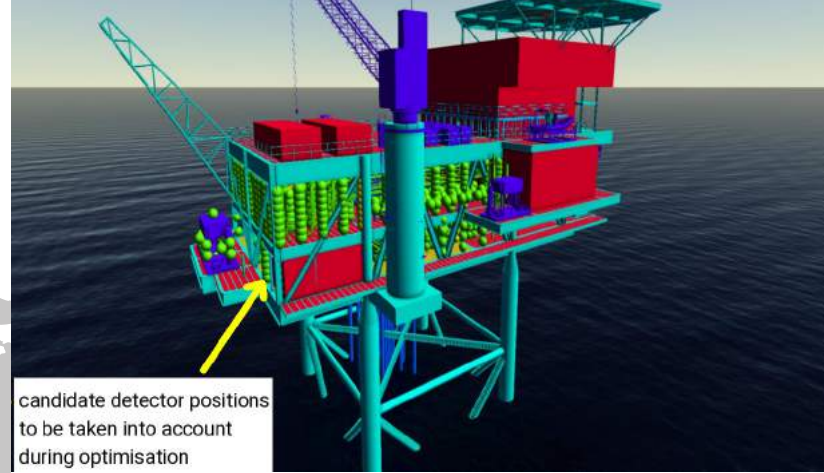
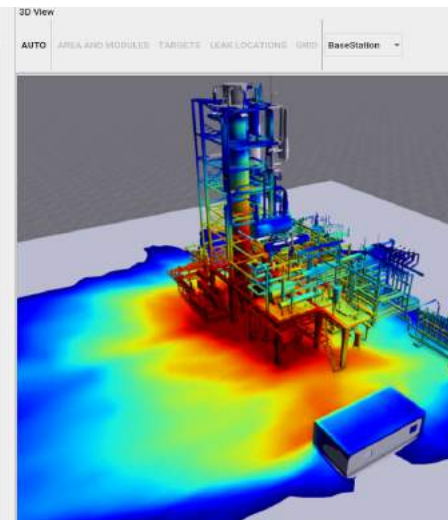
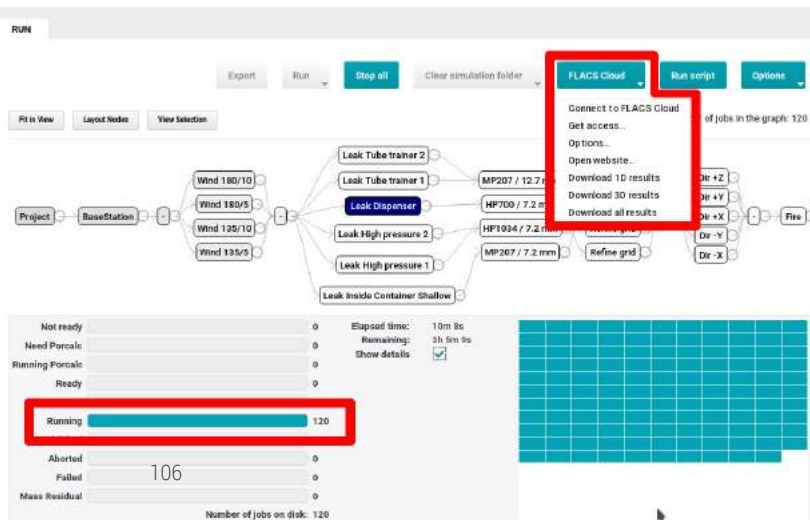

candidate detector positions to be taken into account during optimisation

EXPERIMENT #702 HIGHLIGHTS

Industry Sector:
Oil & Gas Processing

Country:
United Kingdom

Software used:
FLACS Risk, FLACS Cloud

THE SOLUTION

The goal of the Fortissimo experiment has been to provide FLACS as Software as a Service (SaaS) offering, with the usage of HPC fully integrated in the FLACS GUIs, under the new product name "FLACS-Cloud". The new service enables Gexcon's customers to tap into powerful HPC Cloud resources seamlessly from the GUI, so that it appears no different to the user compared to accessing a local cluster. The key difference is that the users only pay for the time that they use, making it much more cost-effective. The access to HPC resources available through the FLACS-Cloud service renders it feasible to apply proper CFD-based optimisation to the placement of gas detection systems. This is expected to result in reduction of the costs for the installation and maintenance of the detection system, and lowering the risk of severe accidents in a facility.

BUSINESS IMPACT

Using FLACS-Cloud, Micropack and other users can improve safety and reduce the costs of detector installations and ongoing operational expenses in industrial and manufacturing facilities that incur potential risks of gas leaks, explosions, fires, and other hazards.

Optimisation means that fewer detectors are needed to cover the same space. The cost savings of one or more detectors per sector of the detection system can quickly add up to figures in excess of €100,000. Typical gas detection systems can easily comprise multiple tens of detectors, so the savings can run into millions of Euro per installation.

The use of on-demand resources is attractive to Micropack, as they save tens of thousands of Euro on computing equipment. Using HPC, a project's computing phase can also typically be shortened by up to a factor of ten (compared to using in-house resources), which will allow to service more clients, and offer a better client experience.

Gexcon will offer FLACS-Cloud via the Fortissimo Marketplace and continue to develop Cloud-based industrial safety software and business models.

BENEFITS

- Potential savings into the millions of Euro for a typical installation.
- The realisation of FLACS-Cloud, creating revenues for Gexcon.
- Computational speedup, up to a factor of 10, using HPC over traditional resources.
- Improved placement of detectors, therefore improving safety.



Advanced, Cloud-based HPC simulation in the foundry business

ORGANIZATIONS

ProService s.r.l. is an SME based in Italy. Founded in 2002, it provides machines, tools and consultancy services for the metal casting industry, focusing on iron foundries. Noesis Solutions is a Belgian system integrator and independent software vendor. Its research areas include integrated simulation frameworks, large-scale optimization and High Performance Computing. Fraunhofer SCAI is the Institute for Algorithms and Scientific Computing of the Fraunhofer Society, based in Germany.



End User



www.proservicetech.it

HPC Expert



www.noessolutions.com

ISV & Domain Expert



www.scai.fraunhofer.de

HPC Provider



www.hlrs.de

THE CHALLENGE

The goal of this experiment was to reduce the scrap rate of the foundry process. A service was needed which could predict the behaviour of the current batch of metal to reduce the amount of waste. If it were possible to adjust the process in real time, the foundry could lower energy consumption and production costs. Using historical data from previous production runs was seen as the key to this problem, but this entails data analytics requiring computing resources far in excess of those available to foundries or consultants like ProService.

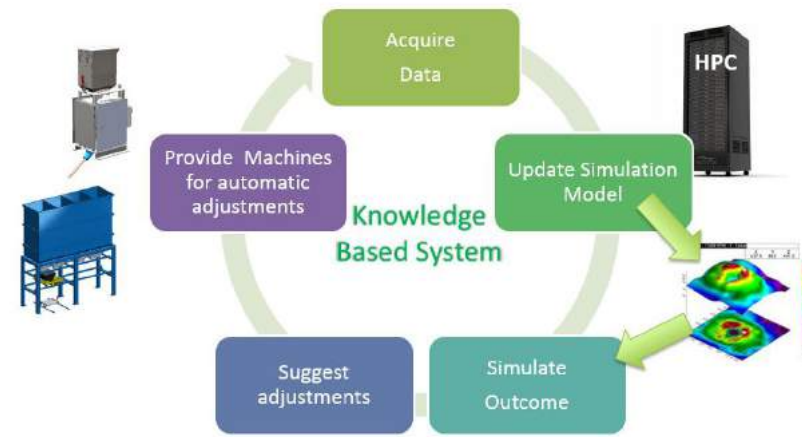
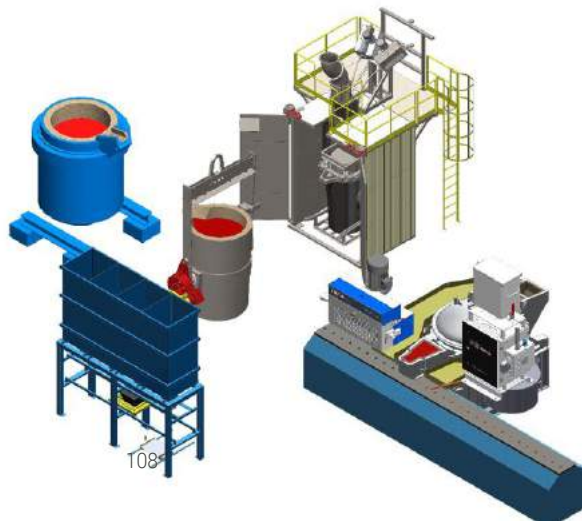

EXPERIMENT #703 HIGHLIGHTS

Industry Sector: Automotive

Country: Italy

Software used: Optimus, ITACA, elasticLM

THE SOLUTION

Noesis and ProService collaborated to develop a new adaptive process for controlling the liquid-iron stage of the foundry-casting process, based on Noesis' Optimus software and ProService ITACA technologies. The two companies worked together to create a model of the process based on historical foundry data, and provided the required expertise to deploy the solution on a Cloud-based HPC platform. Thermal analysis software is used to generate production data, which is sent to the Fortissimo Cloud-based HPC infrastructure. The correction model is updated by the HPC resources based on the production data, and then returned to the foundry system, where the correction is calculated and applied.

BUSINESS IMPACT

For ProService, the tools developed in the experiment mean it can realistically expect to reduce the scrap rate of a foundry customer from a current rate of around 3% to 2,5%. For a small foundry, this translates to a saving of €50.000 per year – with the number growing to €500.000 for the largest facilities. The ability to deliver this kind of saving to a customer puts ProService at a significant advantage over its competitors.

The experiment partners plan to offer the foundry optimisation tools as a service, marketed to end users via the Fortissimo Marketplace. This is expected to provide an annual revenue of €236.000 for ProService.

The EU is one of the largest steel producers in the world, second only to China in terms of output. Around 11% of steel worldwide comes from EU foundries. With increasing demand for cast metal products from developing countries, ensuring the competitiveness of European foundries is key to tapping into a global market. Europe has more than 1.900 foundries. If just 10% of them were to use this system, with each saving the minimum potential of €50.000, this would mean savings for the sector in excess of 9,5 million € per year. The potential of this service is therefore extremely high.

BENEFITS

- Decrease in foundry scrap rate by 0,5%, saving up to €500.000 per year.
- Increase in revenue of €236.000 per year for ProService and ability to offer service via the Fortissimo Marketplace.
- Massive potential saving for EU foundry industry.



HPC-based design of non-circular gears

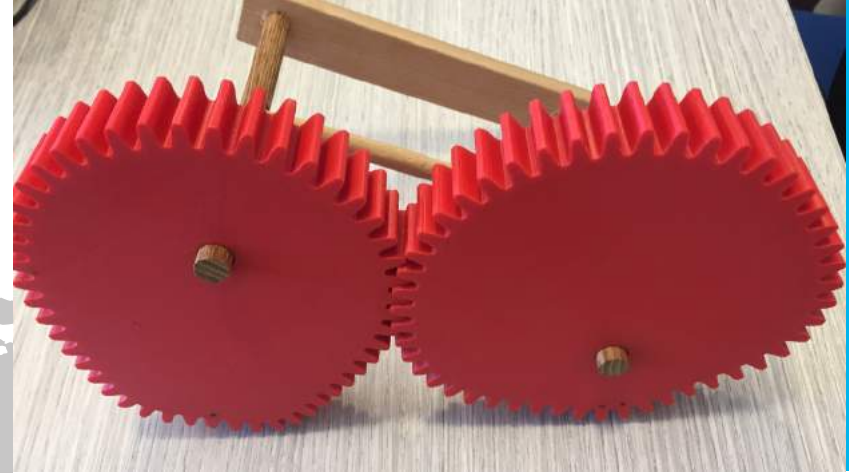

EXPERIMENT #705 HIGHLIGHTS
Industry Sector: **Mechanical Engineering**
Country: **Italy**
Software used: **Optimus, Maple, Matlab**



ORGANIZATIONS

STAM is an Italian engineering and manufacturing firm. Since 2011, it has pioneered the development of Non-Circular Gears, which are used in many sectors such as automation & robotics, defence & security, aerospace, transport, and energy. Noesis solutions is a Belgian system integrator and independent software vendor.



THE SOLUTION

The partners developed an HPC-based engineering workflow for NCG design. The workflow, CloudGear, allows STAM to optimise the design of an NCG in less than 3 minutes, providing fast feedback concerning potential modifications and improvements. Previously, just the computation phase of the workflow would take 25 minutes, not including set-up and results delivery. Due to the near-real-time delivery of results, STAM is able to significantly speed up its internal design process. Using Noesis' Optimus software, the design process was automated and the most computationally expensive part of the process sent to an HPC system. CloudGear will also be offered by Arctur through the Fortissimo Marketplace.

THE CHALLENGE

Non-Circular Gears generate a prescribed motion with great precision, regardless of external factors. This is a highly desirable feature in advanced transmissions. Designing these gears is a complex process that requires a significant amount of expertise and expensive, computationally intensive iterations. In-house computing systems are not powerful enough to perform these calculations. A cloud-based engineering workflow would significantly shorten the time required to design and deliver an NCG. A key element of this is cost-effective access to the necessary computing power.

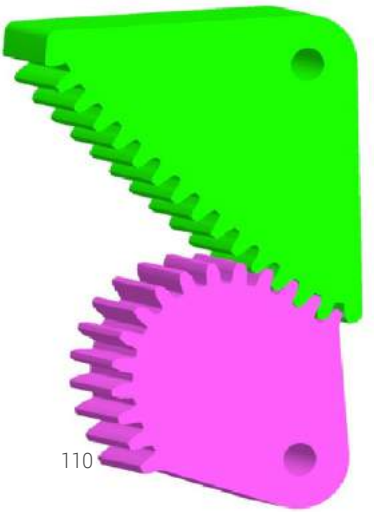

BUSINESS IMPACT

Customers of the CloudGear workflow will be able to design better NCG-based solutions at lower costs. This in turn benefits users of their machinery, plants, prototypes and other products. Five potential customers for CloudGear have already been identified. STAM sells a custom NCG solution for approximately €15.000 each. The CloudGear approach will allow them to sell 8 new solutions in the first year, 10 in the second, and 12 in the third. The reduction in development time and lower manufacturing costs give STAM a significant advantage. Noesis will benefit through an increase in sales of the Optimus software directly related to the sales of the CloudGear solution, as CloudGear is built on the Optimus platform. The Optimus optimization tool is extremely flexible and can easily capture the simulation needs of end users in a number of different industries.

BENEFITS

- Increase in turnover, rising to 20% after 7 years, for STAM, due to sales of NCG-based solutions and software.
- NCGs can be designed faster, and with more advanced features, that would not be possible to simulate without HPC.
- Noesis expects a 3% increase in total sales, worth a total of 1,6 million € over five years.



HPC based high-resolution modelling of magnets

ORGANIZATIONS

Magneti Ljubljana is a Slovenian SME that has produced permanent metallic and systems magnets for the European market for over 60 years. These have many uses in a variety of sectors. XLAB is a Slovenian R&D company with a strong research background in the fields of distributed systems, Cloud computing, system security, information visualization and image processing.

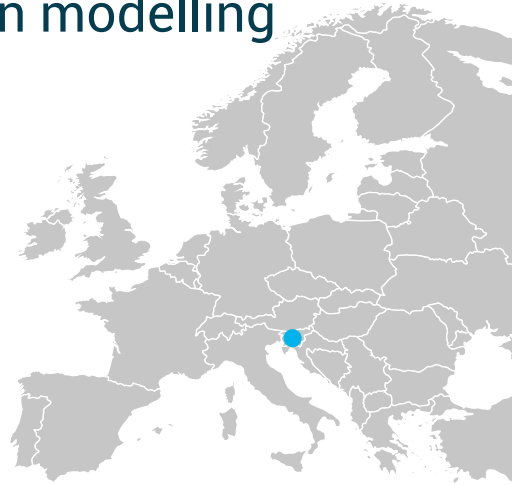

End User



www.magneti.si

HPC Expert



www.xlab.si

HPC Provider



www.arctur.si

THE CHALLENGE

Magneti produces its magnets through a process called compaction, which uses a hydraulic press to apply pressure to magnetic powders until they solidify. The hydraulic press is made up of several very expensive parts which regularly wear out and must be replaced. The pressing tool needed to be optimized, so it could be used for longer and with lower material costs, but doing this requires the ability to automatically detect yielding of the tool under a given pressure. This requires many iterations of computer simulation and post-processing, which exceeds in-house capabilities.

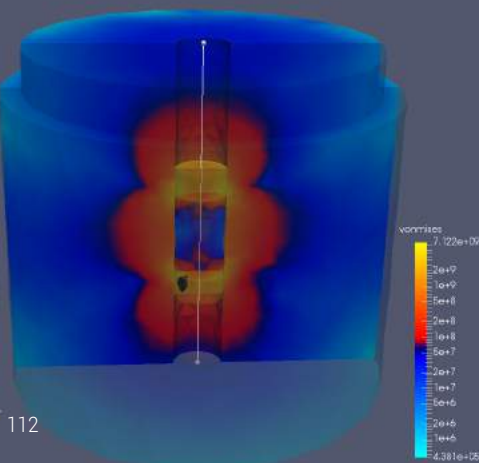

THE SOLUTION

To tackle the problem of pressing tool optimization, XLAB developed a set of software services based on open-source solutions. XLAB built a computer model of the pressing tool and its behaviour during the compaction process. This model is highly configurable, so Magneti can reuse it for other applications. The optimization service runs as a web application, which provides an easy-to-use interface. The application connects to Arctur's HPC system and submits an HPC job according to configuration and input parameters from the end user. This means that even inexperienced users are able to design and run experiments using HPC resources, avoiding the need for costly training. Magneti only needs to pay for the computing resources it uses, providing the company with a cost-effective solution.

BUSINESS IMPACT

The partners in this experiment have derived a number of benefits from their involvement in the Fortissimo project.

For Magneti, there are several benefits. Due to the optimized geometric properties of the pressing tool, the quantity of excess material in an existing tool was reduced by around 32%, reducing material costs. This has reduced the cost of making the pressing tool by 27%, which represents an annual saving of €87.000. The pressing tool is also of a higher quality, containing narrower coils which consume less power. Assuming Magneti replaces all of their pressing tools with those designed by the HPC tool, this will save another €16.200 annually.

XLAB has broadened its software development expertise to the field of magnet production, and gained knowledge about developing complex software with the help of open-source tools. The existing software developed for Magneti can be extended and modified to potential new customers coming from the same or similar industries.

Arctur has increased its reputation in the research community, potentially allowing it to attract new customers from the magnet production industry.

EXPERIMENT #706 HIGHLIGHTS

Industry Sector: **Automotive**

Country: **Slovenia**

Software used: **ELMER, ParaView, NetGen**

BENEFITS

- Design of a better pressing tool that saves money, does not need to be replaced as often, and uses less energy.
- Savings of over €100.000 per year for Magneti and ability to create new services based on improved pressing tool.
- Magneti and XLAB both gained experience in simulation.



Cloud-based HPC optimisation of manufacturing processes



ORGANIZATIONS

EMO is a Slovenian SME specialising in the production of tools and dies for stamping, particularly sheet metal, in the automobile and aerospace industries. EMO utilises laser metal deposition (LMD) technology. AIMEN is a Spanish not-for-profit organization with expertise in laser technologies, manufacturing processes and the development of monitoring systems for industrial applications.

End User



www.emo-orojarna.com

Domain Expert



www.aimen.es

HPC Provider & Expert



www.cesga.es

THE CHALLENGE

LMD is an additive manufacturing technology that enables the generic 3D printing of large metal parts. Additive manufacturing is a rapidly growing sector, as it allows for complex components to be produced with short lead times. However, the lack of sufficient control remains a barrier, as it can result in unnecessary reworking, waste and an increase in 3D printing times. This reduces both profits and efficiency. This experiment aimed to overcome the current deficiencies in online monitoring and control of laser processing, so that EMO can realise the full benefits of additive manufacturing and create better quality products.

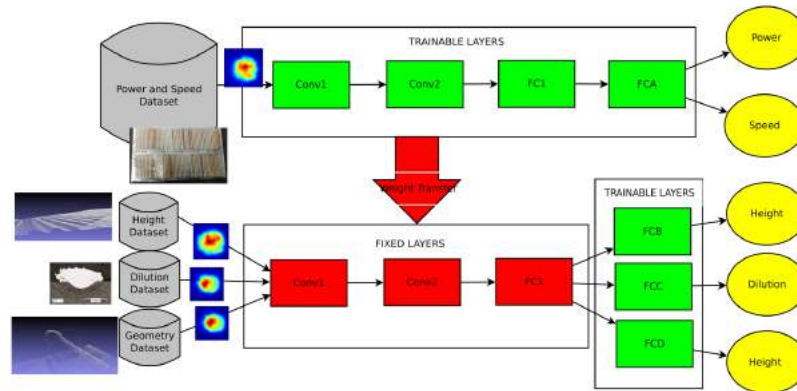

EXPERIMENT #707 HIGHLIGHTS

Industry Sector: Automotive
Country: Slovenia
Software used: TensorFlow

THE SOLUTION

EMO currently uses LMD. As part of this process, EMO needs to gather and analyse significant amounts of data. A more efficient workflow would enable it to complete more projects without extra investment. A new system has been developed in this experiment that exploits recent advances in AI for image analysis and in data acquisition from images of the process. The new technology, called CyPLAM, is a novel approach to the online monitoring of LMD. It uses deep-learning principles, working on the Fortissimo infrastructure, to enable online and real-time quality control and monitoring of key features such as dilution and clad height. CyPLAM has been validated by testing on a repair application using LMD.

BUSINESS IMPACT

CyPLAM addresses the quality issues of LMD-created parts, putting EMO at an advantage as they are first to use the technology. Future CyPLAM users can expect to cut production times by over 30%, as well as producing a higher-quality product needing less reworking. Overall, end users can expect a 20% saving in operational costs and a 30% reduction in lead-time, compared to traditional approaches.

AIMEN will use CyPLAM technology to support its recently launched CLAMIR system, a commercial process control system for Laser Additive Manufacturing.

The experience and knowledge acquired during this experiment have allowed CESGA to obtain new projects and contracts within the industry. They have also created a training course on Machine Learning.

3D printing and other additive manufacturing technologies have had a major impact on the European manufacturing industry, allowing fast and flexible prototyping and part creation. This industry is home to many SMEs due to the comparatively low cost of entry, and is growing fast. The worldwide 3D manufacturing industry is growing at a rate of 25% per year, and is expected to be worth 6,5 billion USD in 2019.

BENEFITS

- Using HPC, EMO can reduce operational costs by 20% and save over 2.000 machine hours per year.
- Users of CyPLAM can stay competitive in the global Additive Manufacturing market.
- As a result of the expertise gained in this experiment CESGA is offering a new Machine Learning service (SaaS) based on TensorFlow.

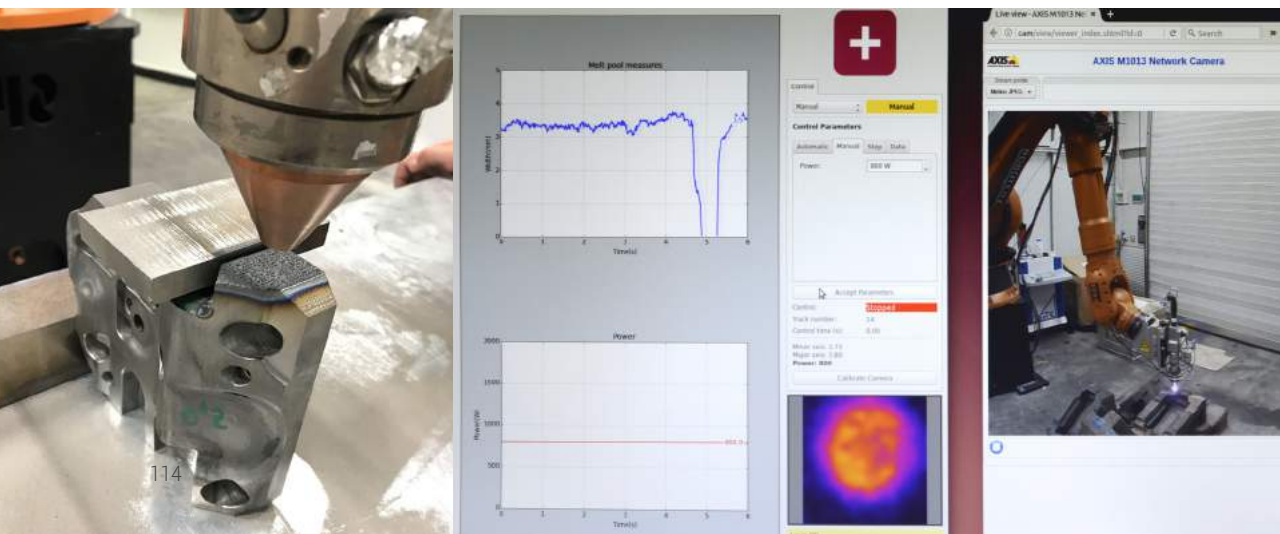



Cloud-based HPC processing for knowledge generation in camshaft manufacture

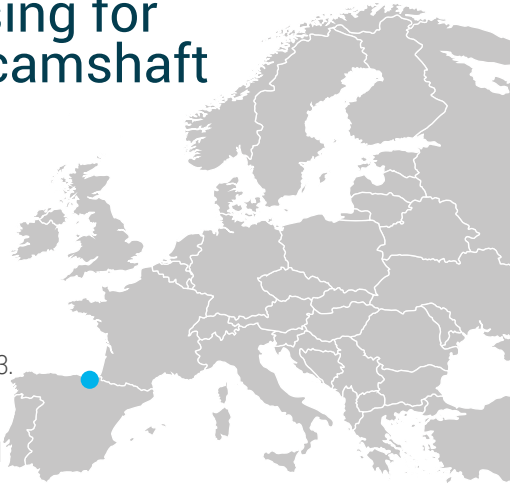

EXPERIMENT #708 HIGHLIGHTS

Industry Sector: **Automotive**
Country: **Spain**
Software used: **M3**

ORGANIZATIONS

EPC Group Europe is headquartered in Spain. It specialises in the manufacture of large camshafts (over 2 meters long) for use in the naval industry, agriculture, military, generators, and other sectors. TRIMEK is a Spanish SME founded in 1993. TRIMEK is one of the main manufacturers of metrological systems and solutions worldwide, and is the 4th worldwide provider and the leading company in the Basque Country and Spanish markets of Coordinate Measuring Machines (CMM).

End User



www.engpwr.com

ISV



www.trimek.com

HPC Expert



www.cesga.es

THE CHALLENGE

EPC manufactures more than half a million camshafts every year. The company needs to ensure that it produces high-quality parts. Monitoring of the manufacturing process generates a massive amount of data which could be used as a basis for machine learning to improve the production process. However, current software solutions are not able to fully process the data fast enough, so the potential knowledge that may be generated from it cannot be exploited. In order to function alongside a busy production line, the solution requires significant computational power, together with the application of novel machine learning technologies.

THE SOLUTION

TRIMEK developed a metrological module of its M3 software, which enables the use of big data resources for data analysis. The new module is able to analyse scanning and measurement data and compare parts much faster than before by using Cloud-based HPC. The production process is therefore more time-efficient. The time savings enables more of the produced parts to be checked in the same amount of time, increasing the overall production quality. Reducing the processing time for data analysis allows a higher knowledge and control of the quality of the production process and of its needs, such as maintenance requirements. By using this system, the end user receives a higher-quality product, saving time and money, leading to benefits for their own client.

BUSINESS IMPACT

TRIMEK, as service expert, developed a new software module for statistical analysis. Due to the optimized data-processing software developed in this project, TRIMEK expects an increase of 20% in new licences sales.

EPC has tested and used the new M3 capacities within their production site, proving its ability to improve production capacity and speed. In a short time, the expected benefits to the internal production process will reduce the number of defective parts to almost zero, resulting in a cost reduction of 1,5 million € over the next five years.

CESGA will exploit the experiment results in its big data platform, which has been analysed and improved to fulfil the requirements of its commercial customers. As initial step, CESGA has created a white paper to show the capabilities of the infrastructure to use as marketing tool to attract other companies to use it. CESGA expects to be able to increase its SME projects and services in the next years to reach the strategic indicators for 2020.

BENEFITS

- 20% increase in turnover over five years for TRIMEK.
- EPC can save 1,5 million € over five years using the new solution.
- The number of defective parts is reduced to almost zero.



Cloud-based simulation of box framed timber beams



EXPERIMENT #709 HIGHLIGHTS
Industry Sector: **Construction**
Country: **Spain**
Software used: **ANSYS Mechanical**

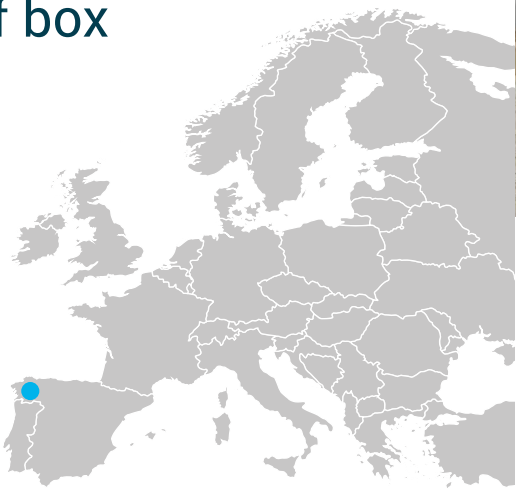

ORGANIZATIONS

Maderas Besteiro is a Spanish SME that specializes in timber solutions for structural applications, such as house-building. It has recently taken an interest in offering a new product line of box framed timber beams made from Eucalyptus globulus. USC-PEMADE is the Structural Timber Engineering Department of the University of Santiago de Compostela.

End User



www.mbesteiro.com

Domain Expert



www.pemade.com

HPC Provider



www.gompute.com

THE CHALLENGE

Eucalyptus is ideal for structural purposes because of its high quality and resistance. Using this wood can allow construction companies to build homes faster, with less waste and less energy, in line with European Union housing guidelines.

Designing and testing a new structural product is an extremely costly process. As an SME, Maderas Besteiro faces a challenge to develop new products due to its small number of staff and lack of sufficient financial resources. A cost-effective computer simulation process would help to solve this problem.

THE SOLUTION

A virtual engineering workflow was designed and validated. The workflow combines the design, calculation and virtual validation stages of the process, through access to a Cloud-based HPC platform provided by Fortissimo. Using this solution has allowed Madera Besteiro to reduce their development costs and design times. A pay-per-use HPC model significantly reduces the computational costs compared to using in-house resources, and results in a better, more refined end product. The company can now optimise Eucalyptus-based solutions at minimum 19% faster than before the experiment. This will allow them to offer a better product at a lower cost than their competitors.

BUSINESS IMPACT

Thanks to the virtual design process offered by the Fortissimo Marketplace, Maderas Besteiro has significantly reduced their cost per m², when comparing the new box framed timber beam with the traditional framing system. Using eucalyptus instead of other hardwoods, their turnover is increased €40.000 per year. More importantly, Maderas Besteiro is now able to easily optimize new designs, meaning that it has a competitive advantage in its industry.

From now on, PEMADE will be able to simulate more complex models than before, including complete engineering structures. Moreover, the ability to simulate hardwood species such as eucalyptus will make it the leading academic group in Spain in this field.

End users of this workflow can reduce their computing costs by up to 81%. From a business perspective, it has an enormous potential as the timber industry has over 400.000 active companies. Gompute is now ready to offer a complete solution in the Fortissimo Marketplace for customers who need to simulate timber structures in a fast, easy and affordable way.

BENEFITS

- Maderas Besteiro can improve its overall productivity by 23%, thanks to optimisation of just one of its products.
- Increase in turnover of €40.000 per year and ability to easily optimise new designs.
- PEMADE have gained the ability to simulate whole complex structures, as opposed to their previous capabilities.

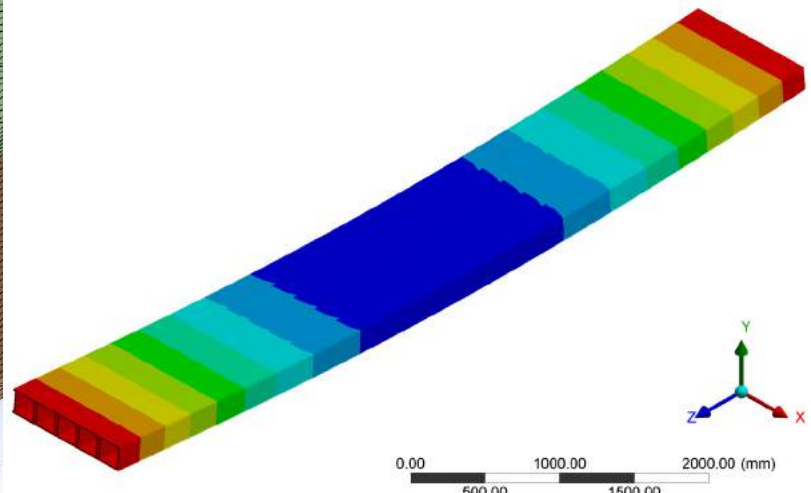
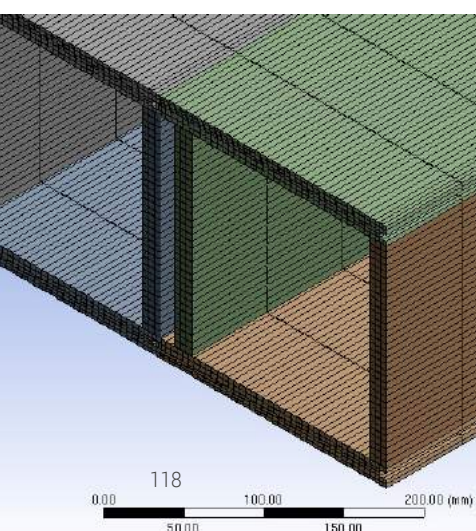



Near real-time analysis of airframe certification test data

ORGANIZATIONS

Colosso is a Dutch SME specialized in the design, analysis and physical testing of high-tech materials and structures, such as those used in the aerospace industry. Within this context, the key focus of Colosso is on the improvement of its processes and products. KE-Works is a Dutch software company. It develops KE-chain, a modelling platform for engineering applications.



End User & Domain Expert

ISV

HPC Provider & Expert



www.ke-works.com

www.gompute.com

THE CHALLENGE

The development of aircraft for civil aviation is driven largely by the economics of the materials constituting the airframe. Improvements in strength and durability can reduce aircraft weight and allow regulators to increase the inspection intervals.

There is a continuous demand for better materials and a greater understanding of how these materials perform in aircraft components. However, introducing a new structural material for an airframe is costly and takes several years, so there is a significant need for better certification processes.

Design

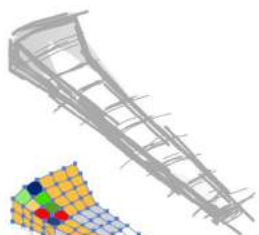

Sizing

- Open hole tension
- Stiffener pull-off
- Bulging
- Intrusion buckling
- Local skin buckling
- Maximum strain

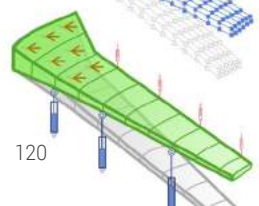

Validation

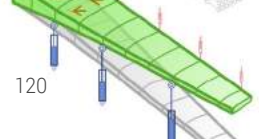

120



EXPERIMENT #710 HIGHLIGHTS

Industry Sector: **Aeronautics**

Country: **Netherlands**

Software used: **Pivotal**

THE SOLUTION

One of the ways of reducing the cost and lead-time of the material qualification process is to improve the predictive capability of material models. Improved models lead to a reduction of the amount of testing required to achieve a reduction in the overall weight of the airframe.

The approach taken in this experiment was to use KE-chain, together with Colosso's data analysis and storage framework to calibrate a new algorithm to model materials based on data from fatigue tests. An HPC environment provided by Gompute was used to provide on-demand computing resources. This resulted in an improved ability to predict crack propagation in airframe components and a reduction in the required amount of fatigue testing.

BUSINESS IMPACT

The results of this experiment directly contribute to the further development of a Colosso's advanced physical and virtual test data monitoring and analysis tool (Pivotal). KE-works will integrate the developed features and infrastructure deployment options in the offerings of KE-chain.

Using HPC will enable (near) real-time data processing and evaluation. A Cloud-based, pay-per-use HPC system means that using Pivotal and KE-chain is much more cost-effective than using in-house resources, making these offerings more competitive.

The experiment, supported by the Cloud infrastructure provided by Gompute, strengthened the competitive position of both KE-works and Colosso. Because of the increased potential and capabilities of KE-chain and Pivotal, an increase in yearly revenue of €50 - 100.000 is predicted.

BENEFITS

- Improvements to the material model for testing airframe components allowed better components to be manufactured.
- Development of a new, promising software product, Pivotal, which can be offered together with KE-chain.
- Increase in revenue of up to €100.000 per year.



Cloud-based HPC simulation of railway infrastructure for high-speed trains

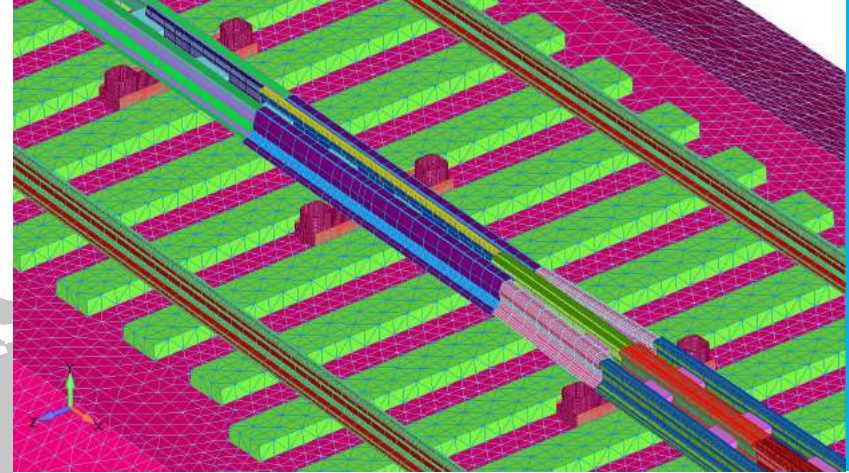

EXPERIMENT #713 HIGHLIGHTS
Industry Sector: **Mechanical Engineering**
Country: **Italy**
Software used: **Siemens NX**



ORGANIZATIONS

Alstom Ferroviaria S.p.A. is the Italian branch of Alstom Transport, a multinational leader in the railway transportation sector. Alstom Transport has a presence in over 60 countries and employs over 28.000 people. A promoter of sustainable mobility, Alstom Transport develops and markets the most complete range of equipment and services in the railway sector.

End User



www.alstom.com

Application Expert



www.hypertecs.it

HPC Provider & Expert



www.hpc.cineca.it

THE CHALLENGE

Alstom is investing huge effort in creating new services for the railway industry and other transportation fields. One of the main areas of investment currently is the development of a diagnostic service to automatically schedule maintenance intervals.

A diagnostic service would need to: understand how parts degrade and determine which would need to be serviced at each interval; automatically plan availability of spare parts or consumables; and quickly report to engineers what needs to be done in order to service the train and the network, as efficiently as possible.

THE SOLUTION

This experiment focused on predicting the effects of failures in different components of the turnout (or set of points), one of the basic part of railways infrastructure, with high accuracy. HPC was necessary as the turnout is a complex and large-sized system, which became even clearer during the course of the experiment. The dynamic interactions between the basic components of the system were studied by taking into account the dynamic load due to the transit of high-speed trains and the failure modes of the turnout. Hypertec Solutions, an Italian SME, was responsible for the development of the model, adapted by CINECA into the Fortissimo Cloud environment.

BUSINESS IMPACT

The major benefits reported by the partners are:
For Alstom, replacing the system based on field measurements with an effective diagnostic monitoring based on simulation has resulted in up to a 50% decrease in time-to-results (from between 16 & 22 months to 8 months), with a corresponding cost saving of between €50.000 and €70.000 per application. In the best case scenario, this will result in a saving of €280.000 per year.
For Hypertec, the experiment allowed it to increase its engineers' skills, enabling new services for Hypertec's industrial customers in many areas of CAE Simulation. It is estimated that, as a consequence, HPC-related revenue will increase 87% in 2017 to €45.000. By 2020, this is expected to reach €100.000 per year.

BENEFITS

- 50% decrease in time required to create a new diagnostic system for a railway component.
- Savings up to €280.000 per year for Alstom, based on optimising four applications per year.
- A predictive service developed which will more accurately monitor the railway network and schedule service interventions when necessary.

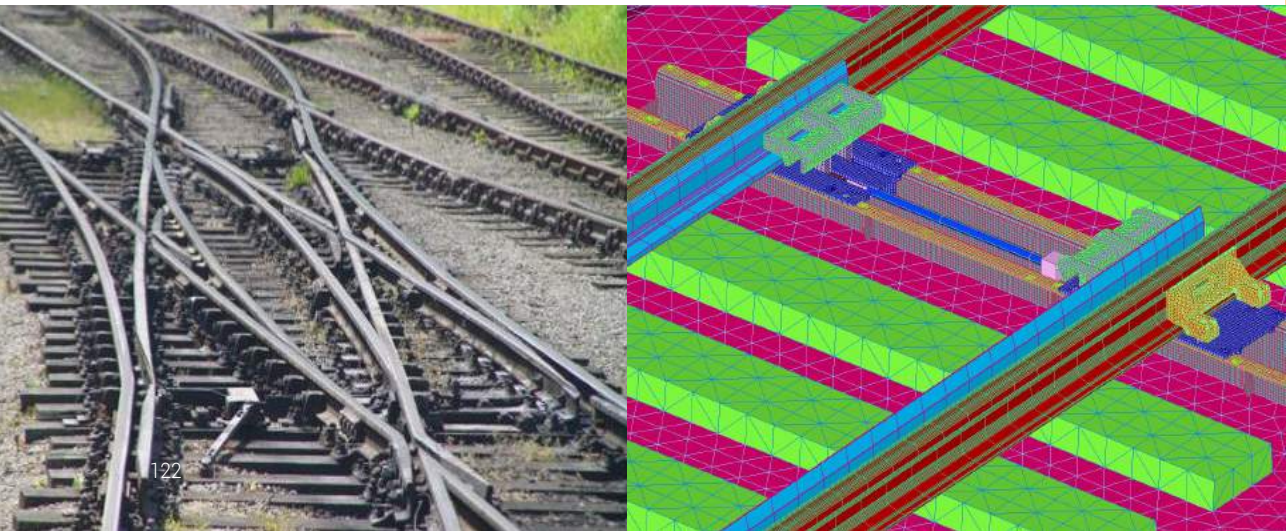



Predictive diagnosis services for the automotive industry

ORGANIZATIONS

TEXA, an Italian SME founded in 1992, designs, produces and sells diagnostic instruments for cars, motor bikes, and other vehicles. This allows for services such as real-time monitoring of fleet vehicles. T2I is an Italian research organisation that supports companies through the design, development and testing of new products and services.



End User



www.texa.com

Application Expert



www.t2i.it

HPC Provider & DA Expert



www.hpc.cineca.it

THE CHALLENGE

Vehicle manufacturers generally have limited knowledge of a vehicle's life once it leaves them. A service that can predict failures, mechanical problems or damage at the component level, and offer detailed information on these components, would be extremely valuable, saving manufacturers and fleet managers time and money. This service would gather and analyse data from TEXA's sensors, which could be used to redesign parts and modify maintenance schedules. This type of analysis requires significant computing power.

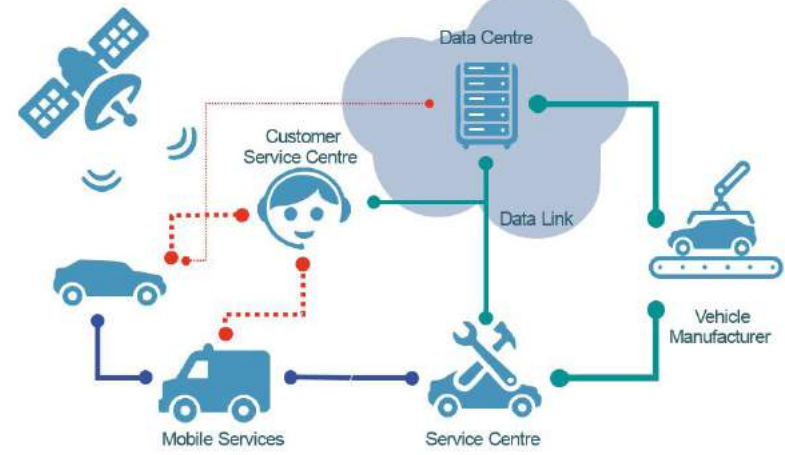
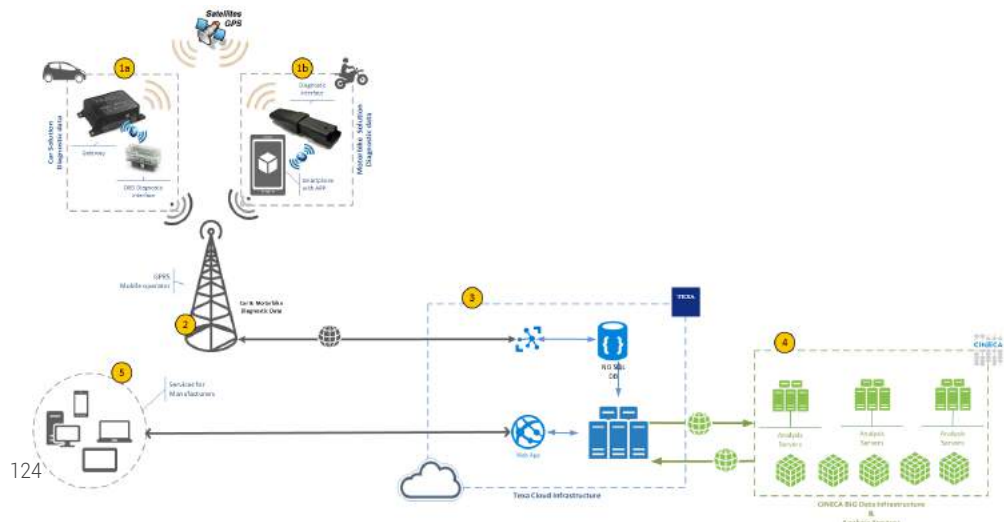

EXPERIMENT #714 HIGHLIGHTS

Industry Sector: Automotive

Country: Italy

Software used: R, R Shiny

THE SOLUTION

During the experiments, four Data Analytics prototype services were defined. These are based information gathered from on TEXA's On-Board Diagnostics (OBD) systems. These services cover areas that may affect the reliability, condition, or service needs of a vehicle - such as how it is driven, failure patterns, and overall health of the vehicle.

A Cloud HPC-powered workflow was developed. This was designed to easily integrate into TEXA's existing automotive Data Analytics services. A service architecture has been defined that connects the existing TEXA infrastructure, equipped to collect data from installed black boxes, to an HPC Cloud provider.

BUSINESS IMPACT

For TEXA, the Net Present Value of these new services is estimated to reach an overall value of 1,2 million € over the next 3 years. The ability to use an HPC-enabled workflow to analyse data from their diagnostics systems will enable better oversight of fleet vehicles and predict failures in time for these to be addressed quickly.

T2I will apply the principles developed here to offer HPC for predictive maintenance in other similar fields (mainly highly "sensorized" products in sectors like home appliances, smart buildings, and energy). T2I estimates a 5% increase in commercial revenues from related services, in years 2018 – 2020, worth up to €105.000.

BENEFITS

- Development of a service using TEXA's "black boxes", which can monitor and predict failures in fleet vehicles. This has value for both TEXA and its customers.
- New services have an overall value of 1,2 million € over three years for TEXA.
- T2I increase revenue by 5% per year, worth up to €105.000 over three years.



Cloud-based simulation of ultra-high-temperature furnaces



EXPERIMENT #801 HIGHLIGHTS

Industry Sector: **Manufacturing**
Country: **Germany**
Software used: **OpenFOAM**

ORGANIZATIONS

XERION (Germany) specializes in the development and production of ultra-high-temperature furnaces and producing new materials for high-tech industry applications. NAVASTO (Germany) is the application expert responsible for the development of the method for the simulation of a high-temperature industry furnace. The HPC provider of the experiment is the HPC Center Stuttgart (HLRS).

End User



www.xerion.de

Application Expert



www.navasto.de

HPC Provider



www.hlrs.de

THE CHALLENGE

Ultra-high-temperature furnaces are one of the critical parts of the manufacturing chain of electronic components. Knowing the temperature distribution and flow inside the furnace is essential for high quality production. As the temperatures can reach up to 3.000° physical measurements are costly. Hence, simulations that provide such data improve the design process. The simulations deal with the interdependencies of convection, conduction, radiation, Joule heating and a complex multi-material geometry, which requires significant computing power.

BUSINESS IMPACT

Only a few companies provide services to high-temperature furnace customers and this experiment will allow XERION to compete in this area. This has already generated considerable interest in XERION's target markets including research institutes and companies using furnaces in their production or research and development activities.

As a result of the experiment, furnaces can be created with improved thermal design. Thanks to advanced modelling, the properties of these furnaces are better understood. This prevents issues such as unnecessary oversizing of components (e.g. heating power) and reduces the cost of the furnace. This can further result in the reduction of the sales price of the furnace system of around 20%.

For NAVASTO, the experiment has resulted in increased expertise in the field of multi-region simulation, high-temperature simulations and simulation process design. It plans to offer this knowledge to its customers via the Fortissimo Marketplace.

Also HLRS has gained valuable knowledge that will allow it to attract more customers from this domain and use this knowledge to provide platforms and services that satisfy their needs.

BENEFITS

- Improved furnace design process and better use of resources associated with modifications performed prior to delivery and after installation resulted in savings up to €25.000 for on-site repairs.
- The price of the furnace can be reduced by about 20% (€40.000) in case of large furnaces.
- There is expected the ROI to be tripled by 2023.

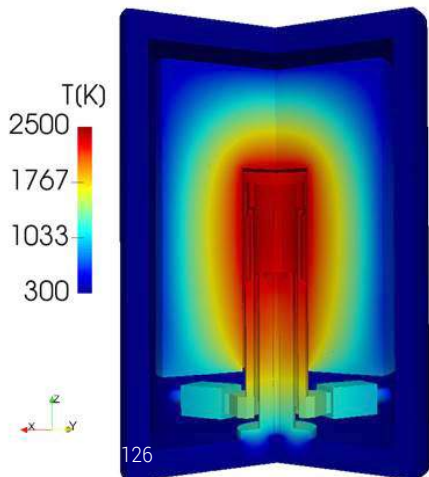



Cloud-based design of yacht sails

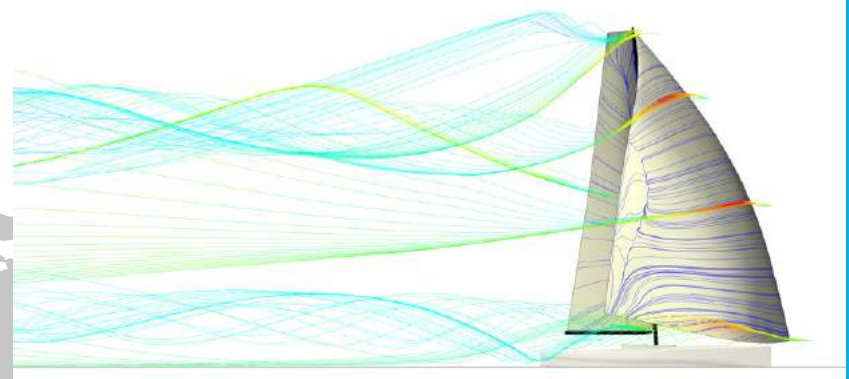

EXPERIMENT #802 HIGHLIGHTS

Industry Sector: **Maritime**

Country: **United Kingdom**

Software used: **AeroSimPortal**

ORGANIZATIONS

Cape Horn Engineering is a UK-based Computational Fluid Dynamics (CFD) consultancy company specializing in the design of racing yachts. PLUS Solutions is an Italian company specializing in tailored software solutions and virtual prototyping in multiple sectors such as Computer-Aided Engineering (CAE). HPC resources and expertise were provided by the Italian HPC center CINECA.



<p>End User</p>  <p>www.cape-horn-eng.com</p>	<p>Application Expert</p>  <p>www.plusolutions.it</p>	<p>HPC Provider</p>  <p>www.hpc.cineca.it</p>
---	---	---

THE CHALLENGE

Cape Horn uses computer simulation to design the best sails for its boats. However, sail design is a very computationally intensive process. Sail design workflows need to analyse the sail's "flying shape", which affects the airflow and pressure. This is achieved with a complex Fluid-Structure Interaction (FSI) coupling between CFD and Finite Element Model (FEM) software packages.

97% of businesses in this area are SMEs. In this sector, there are still technological and cost barriers to accessing HPC-based simulation.

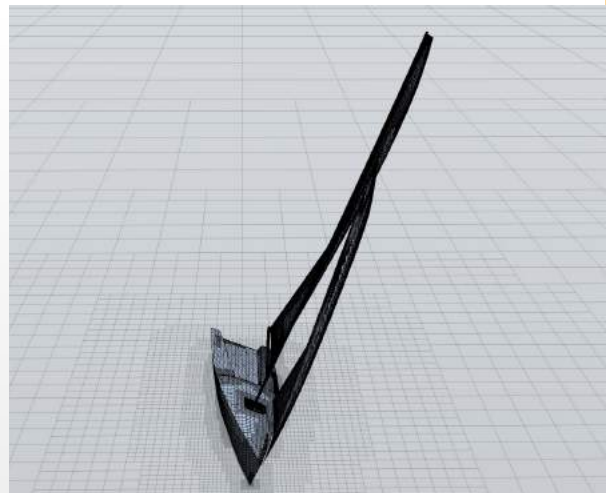
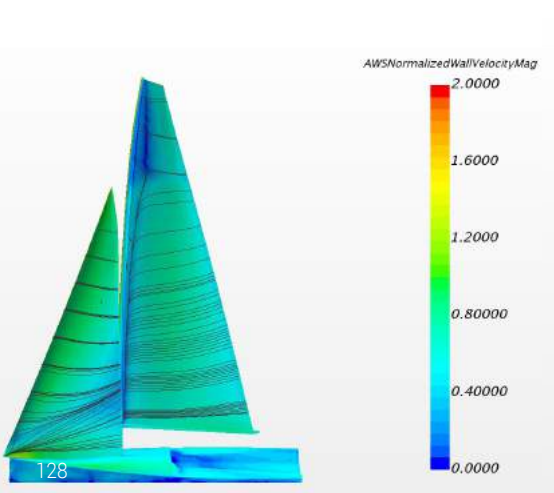

THE SOLUTION

The outcome of this experiment is the development of AeroSimPortal, an easy-to-use tool for sail design studies. This tool removes previously-existing barriers that prevented small companies from using CFD services. Through the use of an HPC web- and Cloud-based simulation platform, all of the necessary tools to analyse sails are made easily available to all companies.

The simple graphical user interface (GUI) allows the user to launch complex CFD/FSI simulations by only uploading a geometry and sailing conditions as inputs. Behind the GUI, there is a fully automated simulation workflow. Therefore, even inexperienced users can now access design tools that they were previously unable to use.

BUSINESS IMPACT

The AeroSimPortal platform constitutes an innovative and sustainable approach to deploying specialized sail design workflows. A Cloud-based solution is especially useful to SMEs, which could otherwise not be able to use these services regularly enough to justify the cost of purchasing their own HPC hardware. The revenue streams resulting from this experiment include both consultancy services and SaaS fees.

Through the AeroSimPortal platform, Cape Horn is able to reduce the cost of its design and consultancy services by around 50% while keeping the same profit margins. This allows the company to have extremely competitive prices and to increase its market share. Beyond the consultancy service, Cape Horn will deploy AeroSimPortal through a scalable pay-per-use platform. The AeroSimPortal is expected to be available on the Fortissimo Marketplace in early 2019.

PLUS and CINECA also benefited from expertise gained through the experiment. They will be able to target customers in the maritime engineering sector and will be able to better compete on the market thanks to this experience.

BENEFITS

- Additional revenues from consulting are estimated at about €300.000 over the next three years.
- Additional income from the introduction of a SaaS platform is estimated at approx. €200.000 in the next three years.
- Significant work time reduction for sail designers since they can concentrate on design issues instead of on fluid dynamics.



Cloud-based estimation of marine freight rates



EXPERIMENT #803 HIGHLIGHTS

Industry Sector: **Logistics**

Country: **Spain**

Software used: **TensorFlow**

ORGANIZATIONS

IMATIA Innovation is a Spanish SME that provides Data Analytics, Artificial Intelligence design and development services. VGSC (Vasco Gallega Sociedad de Cartera, Spain), a company specialising in R&D was the end user of the experiment. They work with companies, who need to ship products by sea and need to find the optimal way of transportation for the lowest cost. CESGA provided HPC expertise and resources for the experiment.

End User	Application Expert	HPC Provider, Expert & Host Centre
www.kaleidologistics.com	www.imatia.com	www.cesga.es

THE CHALLENGE

The logistics chain is an important part of the manufacturing process. Logistics can account for 20% of the final cost of a product for a manufacturing company. What is more, in cases where products need to be shipped by sea, this can rise to 90% of the final product coast. Therefore, finding an optimal transportation option is an important but also complex task. The tools currently available on the market are too slow compared to the fast decision-making that the process requires due to the great number of variables that must be considered.

THE SOLUTION

A software-based solution has been developed, which enables an estimation of the freight cost of any particular shipment. The core of this solution is a neural network (NN) that uses VGSC's historical data, historical information of the market and other external parameters. In order to obtain an optimal NN, a large number of parameters have been studied by building and training numerous specific NN models. HPC proved to be the best tool for creating and training the neural network due to the large number of parameters that need to be included for the best estimation. The solution is delivered as a secure SaaS. Its performance will be improved in the future by retraining when more data becomes available.

BUSINESS IMPACT

IMATIA will offer a service for freight cost estimation. The solution is based on the outcomes of this experiment and is published and promoted as a consulting service via the Fortissimo Marketplace. Furthermore, the solution is combined with several other capabilities that the company provides, such as data processing, multiple data sources information analysis and integration, as well as NN knowledge (especially the TensorFlow).

The SaaS platform developed for the experiment was tested by VGSC workers in order to demonstrate that it is able to interact with their internal software and can be used without any issues. Additionally, VGSC has acquired high-value knowledge about the influence of several parameters from their historical data on the freight rate. This enabled VGSC to improve their internal QA processes and software solutions.

CESGA has improved their HPC machine learning (ML) services and developed a HPC Python toolkit to perform hyper-parametric search on ML problems using the TensorFlow.

BENEFITS

- Better cost predictions and faster quotations, improving the performance of VGSC by 5%.
- Return of €75.000 during a two-year amortization period for VGSC.
- Better logistics know-how enables IMATIA to understand the problems of potential clients from the maritime sector.





Simulation of additive manufacturing processes for the production of metal components

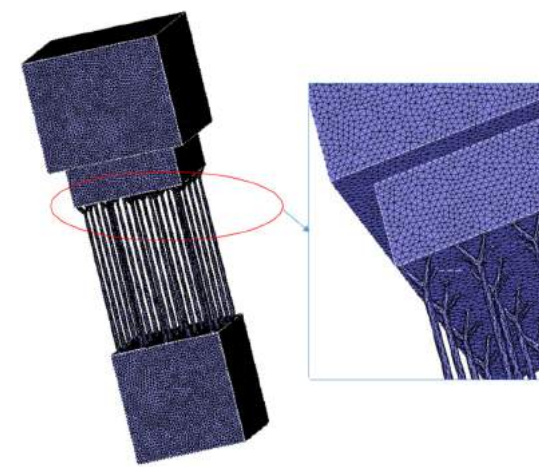

EXPERIMENT #804 HIGHLIGHTS

Industry Sector: **Manufacturing**
Country: **Italy**
Software used: **ABAQUS**

ORGANIZATIONS

HPE (Italy) provides engineering solutions and technology to the automotive, motorsport, automation solution and defence sectors. Their major focus is on powertrain technologies. EXEMPLAR was founded by the Politecnico di Torino University and provides services for Computer Aided Engineering projects. The HPC expertise and resources were provided by the Italian HPC centre CINECA.

End User



www.hpe.eu

Application Expert



www.exemplar.com



www.unimore.it

HPC Expert & Centre



www.hpc.cineca.it

THE CHALLENGE

Additive Manufacturing (AM, also called 3D printing) technologies are generating huge interest in all industry sectors because they enable the rapid design and manufacture of prototypes and end-products. However, there are challenges associated with the use of these technologies such as component failure due to issues with layer deposition. There are multiple points during the fabrication process when the manufacture of a component may fail. In addition, post-production failures of complete parts can also occur.



THE SOLUTION

This experiment provided a numerical analysis environment, which enables users to forecast the results of the AM process using Cloud-based HPC simulation. The forecasting tool is able to predict the stress state of the final component as well as how the product might deform due to differential cooling during the manufacturing process. The multi-scale and multi-physics nature of the problem has been captured in the tool, allowing engineers to better understand the manufacturing process. This approach has created a robust solution by identifying which parameters most impact the quality of the final result before the production itself begins. Hence, it is clear which parameters need to be tightly controlled.

BUSINESS IMPACT

The impact of this experiment for HPE has been the increase of the effectiveness of its optimized AM solutions. Among the major benefits are the reduced time-to-market and the reduced number of defective parts due to a closer match between the initial design and the manufactured part. What is more, this has resulted in lowered production costs.

In terms of the reduction of time required for tuning the AM process, there were two main outcomes. Thanks to this experiment, the build failures and multiple design iterations can now be avoided. The benefits for HPE could actually be replicated for any SME that purchases the service via the Fortissimo Marketplace. Furthermore, the results of the experiment are expected to increase HPE's market share by 50% and reduce costs by €90.000 per year, thanks to the lower levels of material wastage.

EXEMPLAR is able to offer the technology developed here as a commercial service under a SaaS model, with a potential annual turnover of €125.000.

BENEFITS

- HPE reduced time-to-market of their products.
- The number of defective parts is reduced.
- Savings in the amount of up to €90.000 per year.
- EXEMPLAR expects an annual turnover of €125.000 from the SaaS offer.



Cloud-based design of ultra-clean containers for high-purity chemicals



EXPERIMENT #805 HIGHLIGHTS
Industry Sector: **Manufacturing**
Country: **Germany**
Software used: **MpCCI**



ORGANIZATIONS

RIKUTEC is a leading developer and manufacturer of molded containers. Fraunhofer SCAI (Germany) is a non-profit R&D institute providing software development. Hagen Engineering and Hagen Engineering (Germany) are domain experts in plastic parts and blow molded articles. Accuform (Czech Republic) provided the process simulation software B-SIM. Gompute (Sweden) provided the HPC resources.

End User	HPC Expert	ISV	Application Centre & Engineering Service Provider	HPC Provider
www.rikutec.eu	www.scai.fraunhofer.de	www.t-sim.com	www.hagen-stiftung.de	www.gompute.com

THE CHALLENGE

Extrusion blow molding is the standard method for manufacturing hollow plastic parts such as bottles, cans and large containers. A specific example is ultra-clean containers for the microelectronic device industry. Companies manufacturing these products need faster, more reliable and efficient design methods. Prior to the experiment, the automated optimization the individual design and simulation had to be carried out manually. The existing process used a standard workstation system, with one single design loop taking up to 2 days.



BUSINESS IMPACT

RIKUTEC benefits from this experiment through access to more reliable and efficient design methods with faster response times. The number of design iterations was reduced and the quality of products is enhanced. Through the application of simulation methods, substantial cost savings were achieved. Hagen Engineering is using the experiment results to expand its market position as a provider of simulation services. More companies are expected to use CAE-methods in the design process of plastic parts in the future because the access to an automated, integrative CAE work-flow makes them more competitive. The extension of its multi-physics software solution will help Fraunhofer to find new customers. Over the next 2-3 years Fraunhofer expects 5-10 new users with license revenues of €30.000 to €60.000 per year. In the medium term, Fraunhofer expects to see a rapid increase in the market for integrated manufacturing simulation solutions. Interface tools like the MpCCI Mapper will enable Fraunhofer to exploit that market growth.

BENEFITS

- Reduced costs for each design loop amounting to more than € 20.000.
- Optimization of item weight reducing the total costs by several thousand euros per year.
- Due to the use of HPC the computation times are shortened by a factor of 4 - 5.



Cloud-based simulation of the hydrodynamic resistance of ships' hulls in the presence of waves

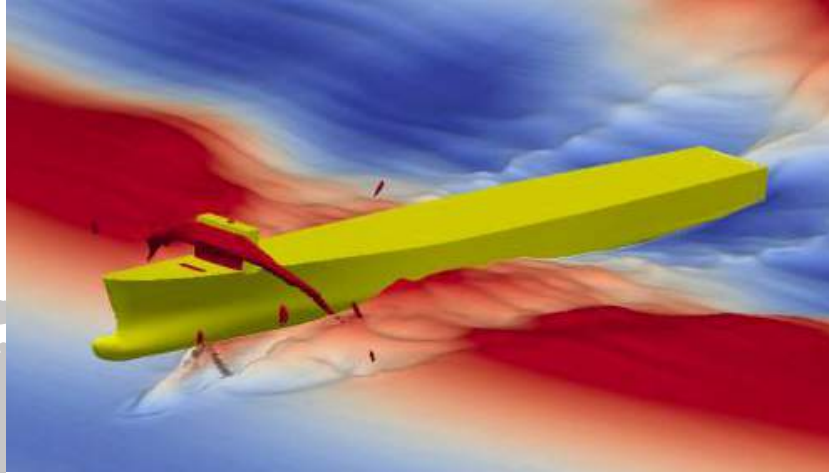

EXPERIMENT #806 HIGHLIGHTS

Industry Sector: **Maritime**
Country: **United Kingdom**
Software used: **HELYX**

ORGANIZATIONS

The Numerical Algorithms Group (NAG) is a UK HPC expert and software supplier. ENGYS is a UK ISV specialising in open source CFD solutions including the HELYX software used in this experiment. CETENA is an Italian company specialising in the maritime field. EPCC, the supercomputing centre at the University of Edinburgh, was the HPC provider.



End User

ISV

HPC Expert

HPC Provider & Host Centre



www.cetena.it

www.engys.com

www.nag.co.uk

www.epcc.ed.ac.uk

THE CHALLENGE

Developing effective methods to achieve accurate predictions of additional ship resistance in waves is currently the priority for ship designers and maritime consultancy companies. Physical testing is time consuming and expensive. Hence, accurate and reliable numerical methods need to be developed as a viable alternative to traditional experimental tests. In this respect, the potential savings for a shipbuilding company could amount to more than €100.000 per year by reducing the need for experimental models in favour of an HPC-based simulation analysis.

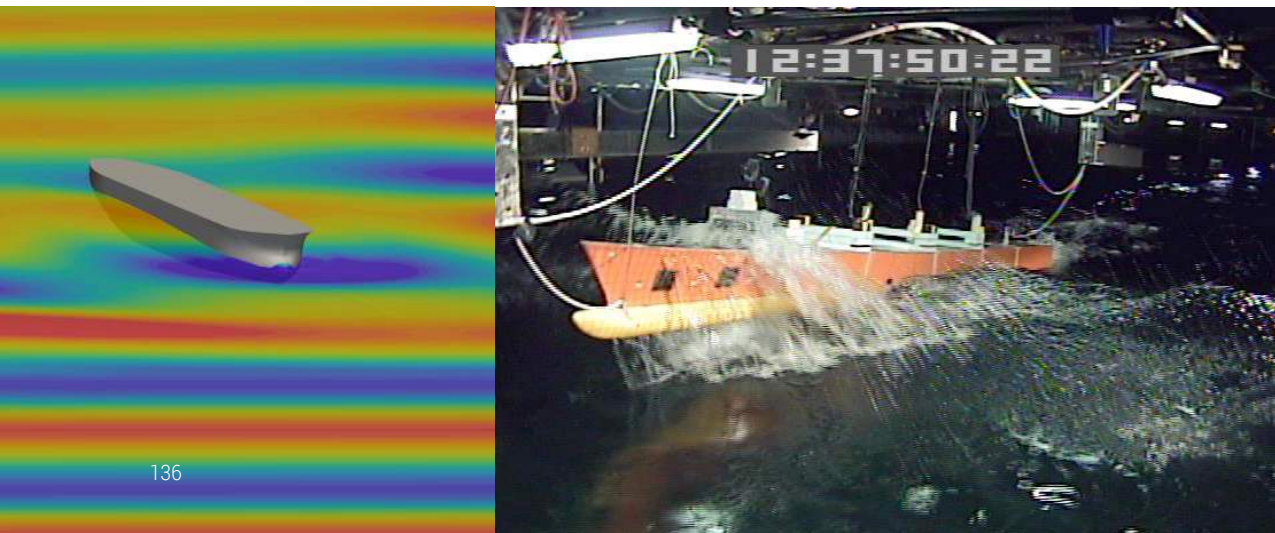

THE SOLUTION

Performing the simulations in-house with the required degree of accuracy is not a viable approach for a SME as it takes too long. A single wave and speed condition simulation takes multiple days to complete on a medium size HPC cluster with 80 to 100 cores. Methods that need less computing time exist, but do not produce results of a sufficiently high quality. The solution is to use a Cloud-based HPC approach, in which multiple jobs can be submitted to a large on-demand HPC resource. The HELYX client has been adapted to be able to submit jobs to the HPC service seamlessly. The software that runs on the HPC system has been optimized to run efficiently on multiple cores and return the results quickly to the user.

BUSINESS IMPACT

Potential savings for CETENA can amount to more than €100.000 per year by employing the HPC numerical solutions developed. The pay-per-use business model is highly attractive for SMEs, as the purchase and maintenance of an in-house cluster are too expensive.

The results of the experiments will enable ENGYS increase the sales of both HELYX and HELYX-EcoMarine products. State-of-the-art CFD software solution for advanced ship resistance combined with on-demand HPC will offer a competitive advantage for users. The target market is huge, with over 830 active shipbuilders and shipyards operating worldwide and a predicted global revenue of €240 billion by 2019, representing a five year projected 1,2% annualized growth. In Europe alone, there are over 150 large shipyards with a global market share of around 6% in terms of tonnage and 35% for marine equipment, totaling €60 billion in annual turnover according to official EU figures from 2012. As a first step towards exploiting this large market, the partners are currently targeting a small group of companies in the maritime industry located in Italy, Japan and South Korea to take-up the technology developed in Fortissimo.

BENEFITS

- Lower computational cost and no need for expensive physical model tests.
- Higher quality of results due to the use of Cloud-based HPC.
- Severely reduced time in the design cycle due to being able to analyse multiple scenarios in parallel.
- Potential savings that could amount to more than €100.000 per year for a typical user.



Cloud-based micrositing of small wind turbines

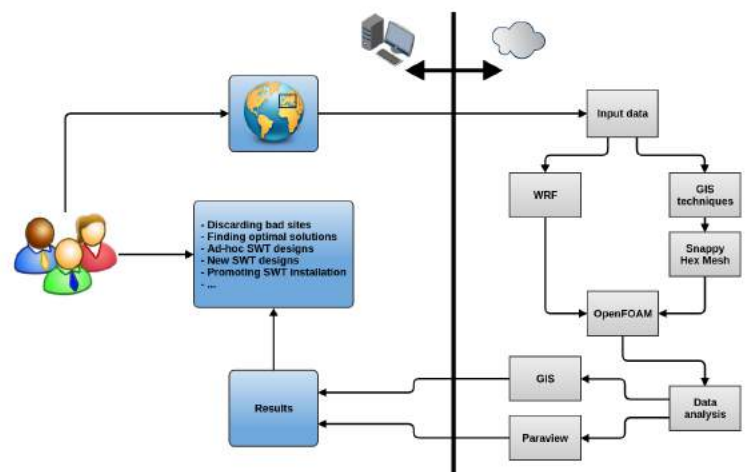

EXPERIMENT #807 HIGHLIGHTS
Industry Sector: **Energy, Civil Engineering**
Country: **Spain**
Software used: **OpenFOAM**

ORGANIZATIONS

KLiUX Energies (Spain) manufactures vertical-axis wind turbines for urban and residential environments. The University of Zaragoza (UNIZAR-BIFI, Spain) hosts its own computing centre and provided application expertise. nablaDot (Spain) provided CFD consultancy services for the experiment. Gompute (Sweden) is a HPC solution provider. It provided the HPC expertise in this experiment.

- | | | | |
|--|--|--|--|
| End User | Application Expert | Host Centre | HPC Provider & Expert |
| | | | |
| www.kliux.com | www.bifi.es | www.nabladot.com | www.gompute.com |

THE CHALLENGE

Wind flow over urban areas is very difficult to characterize. This is due to a number of factors, such as high turbulence and other strong effects created by complex urban geography. When placing wind turbines, it is critical that the detailed flow pattern of the area is well understood. Current urban wind assessment tools are costly in relation to the cost of a small wind turbine. It can take up to a year and cost €12.000 to carry out the necessary physical measurements, which can easily double the cost of placing a single turbine.

BUSINESS IMPACT

The main output is the tool developed for the evaluation of turbine placement in urban environments. Although currently the tool still requires some manual intervention, the goal is to eventually offer it as an online pay-per-use service. Meanwhile, nablaDot offers it as a consultancy-based service. Estimating the average wind speed, wind direction, air density and wind hours available at every site is crucial for KLiUX to determine which wind turbine size model is most appropriate for each installation site and significantly increased KLiUX's ability to compete.

nablaDot plan to use the technology developed in this experiment commercially (initially as a consultancy, moving to SaaS later) with an expected increase in turnover of €150.000 annually in the medium term and the creation of two new job posts. When the number of users increases a higher turnover of extra €300.000 is expected and the creation of three more job posts.

This experiment has allowed UNIZAR-BIFI to experience working with multi-workflow solutions. This experience proved to be extremely useful as it is beneficial to other clients, which may have complex computational needs.

BENEFITS

- Yearly saving of €80.000 to €120.000 for the end users of KLiUX.
- Additional sales of its products are expected to increase revenues by 20% to 40%.
- nablaDot expects an increase in turnover of €150.000 annually in the medium term, increasing this to twice as much in the longer term.

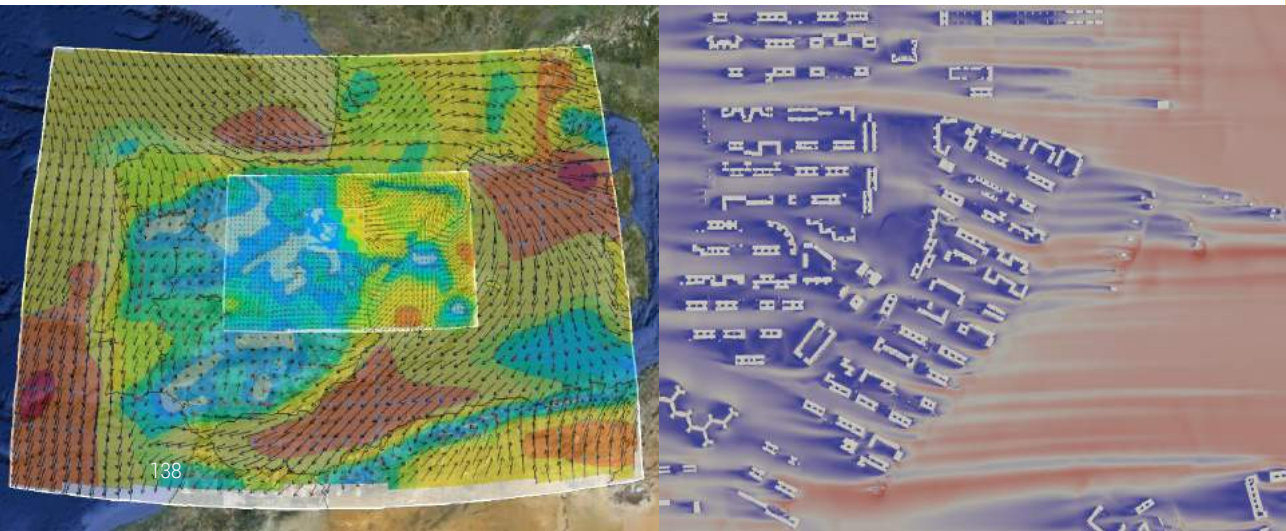



Cloud-based simulation of page curling in the copying of documents



ORGANIZATIONS

Bookscanner is a Greek company that specializes in digitizing printed material. Vertoyo is a Greek SME, which specializes in technology development and software service provisioning in the digitization field. HPC expertise were provided by The Laboratory of Robotics and Automation, Democritus University of Thrace. Arctur, the Slovenian HPC centre, was the HPC provider.

End User	ISV	HPC Expert	HPC Provider & Host Centre
www.bookscanner.gr	www.vertoyo.com	www.duth.gr	www.arctur.si

THE CHALLENGE

Digitization of books is an important process, both for commercialization and for preservation of older texts. The Bookscanner© product can automatically and physically turn pages and automate the scanning process. However, this process results in a 'page curling' effect where the pages are attached to the spine. The scanned pages need to be digitally flattened, a tedious and expensive process that this experiment aimed at improving and commercializing.

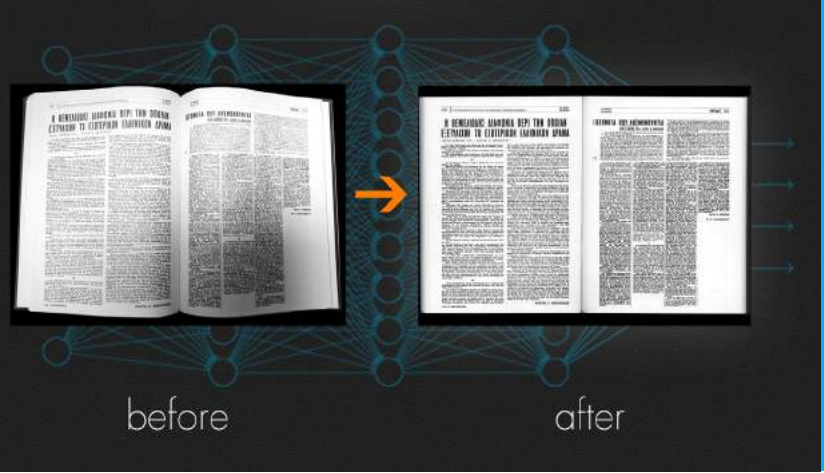
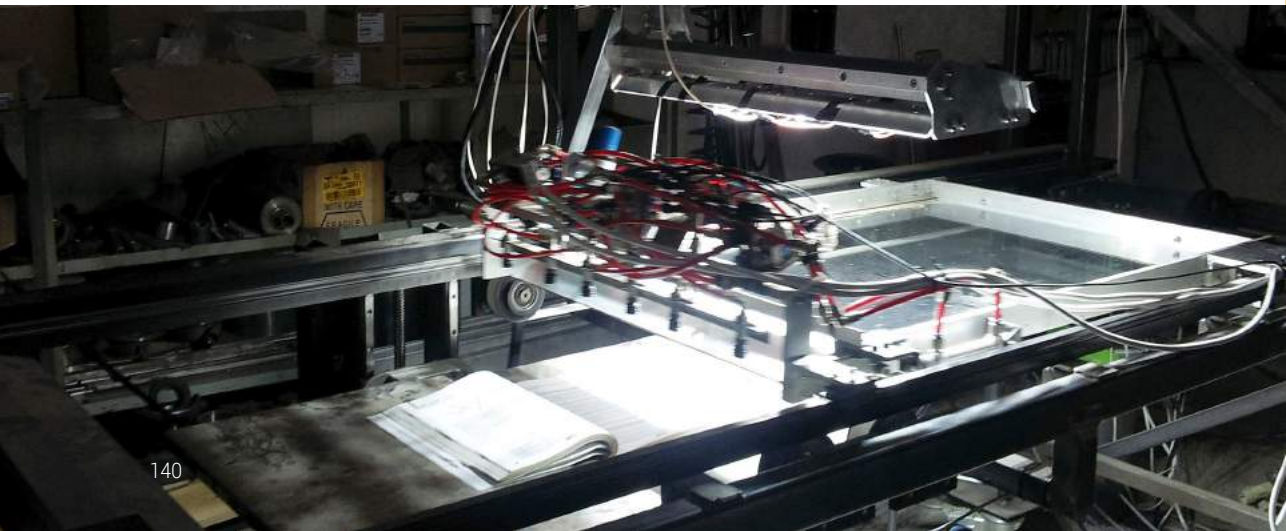

EXPERIMENT #808 HIGHLIGHTS

Industry Sector:
Digital, Data Analytics

Country: **Greece**

Software used:
CURLO

THE SOLUTION

A Deep Neural Network (DNN) has been trained using simulated page curling of 1 million images. The algorithm takes two already cropped pages from a book image and outputs an artificially curled book page. Using the artificially curled book pages, a state-of-the-art deep Convolutional Encoder-Decoder (CED) Neural Network was trained in order to apply the de-curling process. After training, the DNN can de-curl newly scanned pages with very good success rate. Evaluation of the page de-curling problem showed accuracy of curling correction in over 90% in most cases. With the computational power provided by HPC, the training procedure of the DNN is at least 30 times faster than using a typical workstation.

BUSINESS IMPACT

The only current method for page curling correction is based on a projected laser grid that requires each page to be scanned twice. The solution created by the experiment, which is called CURLO, removes the need for additional laser grid projection equipment and provides a 50% improvement on the standard curling correction procedure.

As a result of this experiment, the CURLO solution can be offered as a post-processing service to accompany the Bookscanner© product. The collaboration with Arctur has allowed an improvement in the quality of batch-mode scanning. This will be offered as a Software as a Service (SaaS) framework for scanned page de-curling.

In addition to the digital content market, the partners in this experiment are ready to address the needs of digitization and the paperless economy, e.g. insurance and paperless banking. Especially regarding for the banking sector, the most recent studies estimate that productivity improves up to 39% when electronic forms replace paper and workflows are used to streamline processes.

BENEFITS

- Automatic de-curling of pages and time savings.
- Increase of 10-15% in revenues for participating SMEs.
- Payback period for the CURLO investments is 3-4 years.
- The excess revenue after 3 years is estimated at approximately €300.000 - €350.000.



Data analysis to improve the welfare of laboratory animals

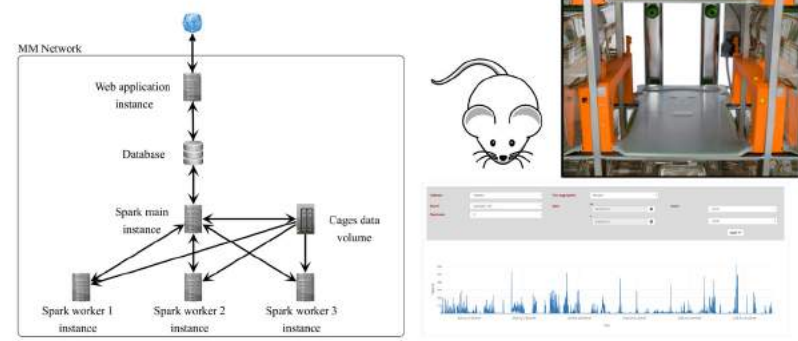

EXPERIMENT #809 HIGHLIGHTS

Industry Sector: **Manufacturing, Data Analytics**

Country: **Italy**

Software used: **In house code**

ORGANIZATIONS

Tecniplast is an Italian company, a worldwide leader in the laboratory animal industry, providing solutions and services to support research. Moxoff is an Italian SME with a deep knowledge in data intelligence and mathematical/numerical modelling. CINECA is one of the largest HPC centres in Europe, eager to facilitate external access to its systems for industry and SMEs.

End User



www.tecniplast.it

HPC Expert & ISV



www.moxoff.com

HPC Provider



www.hpc.cineca.it

THE SOLUTION

A measurement system using a variety of sensors to provide real-time tracking of lab animals has been developed. Moxoff developed a High Performance Data Analytics (HPDA) platform on an HPC infrastructure, implementing algorithm which process all the raw data recorded by the sensors of Digital Ventilated Cages (a Tecniplast product). It can be used for automatic event, anomaly detection, interactive data exploration and analysis. As the system incorporates potentially thousands of sensors, depending on the number of animals in the study, cloud-based HPC infrastructure was necessary to cope with the large amount of data. The real-time nature of the system is another reason why HPC is considered necessary as other computing solutions would be too slow.

THE CHALLENGE

In addition to errors of measurements, any form of human inspection of laboratory animals used for research disturbs their environment and causes stress, which can potentially affect the results of the research. There are two types of measurements: research measurements and measurements made to care for the animals. A system of quantitative measurements of animal health status and activity would allow accurate information of the overall health of all animals to be seen, and issues dealt with as they arise to support the ongoing research.

BUSINESS IMPACT

The offering of this new unique measurement system product allows Tecniplast to increase its current market share and to expand its customer base. As there is a very large potential market, this could be one of the most important data analysis services ever provided by Moxoff. By continuing their partnership, Moxoff and Tecniplast will be able to offer new services to Tecniplast customers as well.

The platform developed in the experiment will be extended in the future in order to be applied to many IoT contexts and markets. Automatic identification of states and trends, user behavior profiling, predictive maintenance etc. are applications that are increasingly important in the market due to the exponential growth of connected devices in the recent years.

In addition to acting as the provider of choice for the platform when the workflow will be implemented at a production-ready level, the HPC centre CINECA will benefit from the success of this experiment by acquiring numerous SMEs in the HPDA market as future customers.

BENEFITS

- Tecniplast expects to increase revenues by over €800.000 per year with a gross margin of 90%.
- Tecniplast expects to increase their market share as their service offer is now much more competitive in the market.
- Moxoff and CINECA have the opportunity to enter a new market.



Complete Data, Time: 2013-08-03 00:00:28

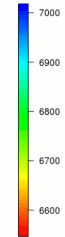
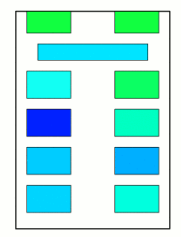

Trend, Time: 2013-08-03 00:00:28

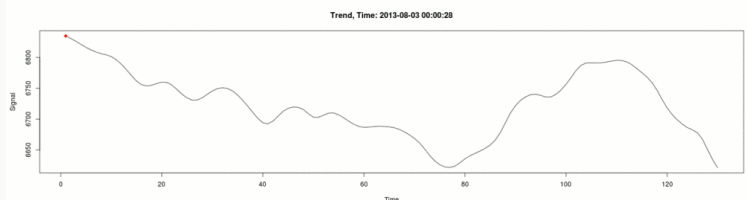
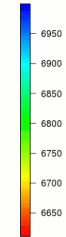
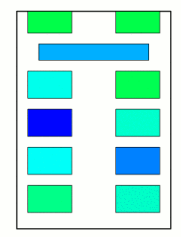



Cloud-based optimisation of a multi-body wave energy device



EXPERIMENT #810 HIGHLIGHTS
Industry Sector: **Maritime, Civil Engineering**
Country: **United Kingdom**
Software used: **OpenFOAM**



ORGANIZATIONS

Zyba is a UK registered SME with expertise in digital and numerical modelling. Since 2014, Zyba's primary goal is to engineer simple systems that work with nature. Together with BioRock Technology, Zyba is harnessing wave energy to protect coasts from erosion, enhance coral reefs and deliver sustainable power. HPC resources and expertise in this experiment were provided by Arctur.



THE CHALLENGE

Zyba's core product, CCell, is a curved wave energy converter designed to be efficient and simple to assemble and operate. It moves with the waves to simultaneously extract their energy for electricity and reduce their impact on the beach. BioRock reefs use the low-voltage charge from CCell to form limestone rock from seawater minerals that serve as habitat for corals to grow at an accelerated rate, creating an active breakwater to protect shores from erosion. Optimization of the CCell for each site is heavily dependent on the local environment and is a computationally intensive task, which is too expensive for most SMEs' budgets as is physical testing.

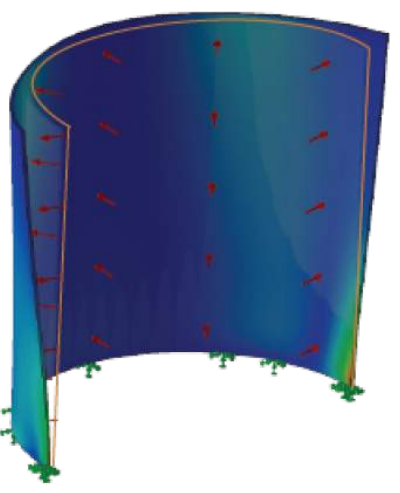
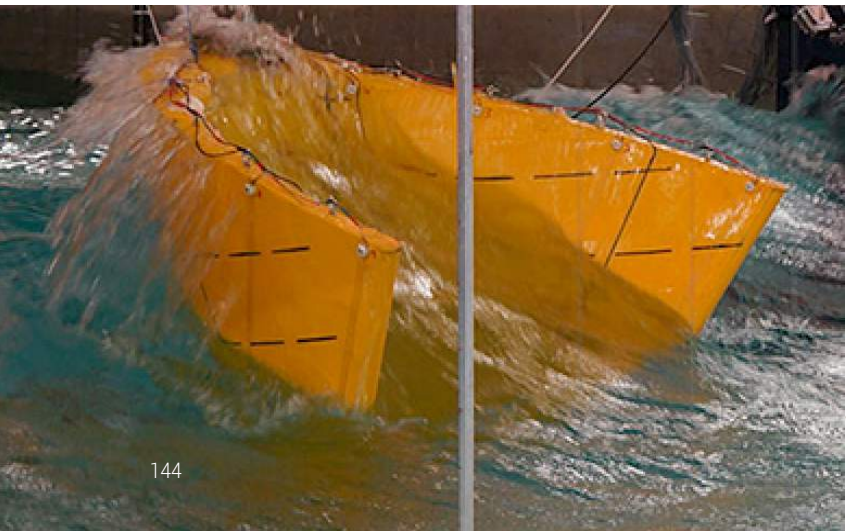

THE SOLUTION

Simulations of the CCell device in different incoming wave conditions were carried out using the OpenFOAM software package on an HPC machine. In addition, an easy-to-use GUI was developed, which allows simulations to be set up quickly and to show a series of scripts and tools written to streamline of the workflow on the HPC system. The increased computation power allowed the whole CCell system to be modelled for the first time, including power-take-off hardware, software, and the intended control logic. This information provided a completely new insight into how the different pieces of the system work together.

BUSINESS IMPACT

As a result of the experiment, Zyba has been able to increase its productivity and deploy a series of pilots offshore. The automated and streamlined design process enabled it to rapidly optimize each design as well as reduce design costs and development time. With the new GUI, less experienced users can now complete design tasks on their own, which empowers individuals within the team and increases the rate of innovation. Overall the new system has enabled Zyba to significantly speed up its market entry with saving around 9-12 months and will continue to facilitate the evolution of future products and service offerings. Provision of resources from an HPC centre transforms an imposing capital expense to a more manageable operating cost. Administrative tasks associated with IT management and upgrades are also effectively outsourced, alleviating pressure on a small SME team and allowing them to focus on their design work.

BENEFITS

- Reduced simulation set up time from 2 hours to less than 1 minute.
- Mitigated use of physical modelling, providing a nine-fold reduction in cost.
- Reduced HPC costs from 0,09€/core-hour to 0,05€/core-hour as all software used was open source.
- Ability to concurrently run simulations improved productivity by a factor of seven.



CAE driven design of a water treatment plant

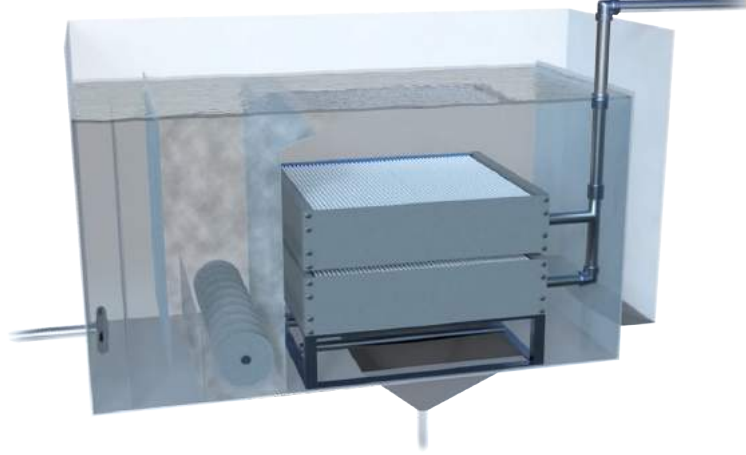

EXPERIMENT #901 HIGHLIGHTS

Industry Sector:
Wastewater Treatment

Country: **Germany**

Software used:
OpenFOAM

ORGANIZATIONS

AKVOLA TECHNOLOGIES provides cost-effective solutions to clean hard-to-treat industrial wastewater containing high concentrations of oil and suspended solids. NAVASTO is a SME, which offers engineering services in the field of flow dynamics for the development of complete product solutions. ARCTUR, the Slovenian HPC centre, is the HPC Provider.

End User	Application Expert	HPC Provider
www.akvola.com	www.navasto.de	www.arctur.si

THE SOLUTION

During the experiment, investigations were conducted on a prototype plant to enable a calibration of the simulation process. After developing a reference cases for several aspects of the simulation, the resulting flow fields match very well with the experimental data. The validated and fully automated numerical workflow then could be used to identify regions inside the wastewater plants where the flow structures are unfavourable for the floatation-filtration process. Subsequent improvements can be evaluated with very short turnaround times. This speedup in the design process is enabled by the combination of the open-source software OpenFOAM in combination with Cloud-based HPC.

THE CHALLENGE

Enabling efficient and sustainable water cleaning is one of the main challenges of the 21st century. To tackle future challenges, Akvola as a first time HPC resource user, wanted to research the viability of devising a water treatment plant entirely based on CAE technology. The goal of this experiment was to gain the ability to simulate an industrial-water treatment plant with sufficient accuracy. This would enable Akvola to improve their design process from an experiment-based workflow to a more economic CAE-based design process. The simulations required significant computing power and a validation of the numerical model against experimental data.

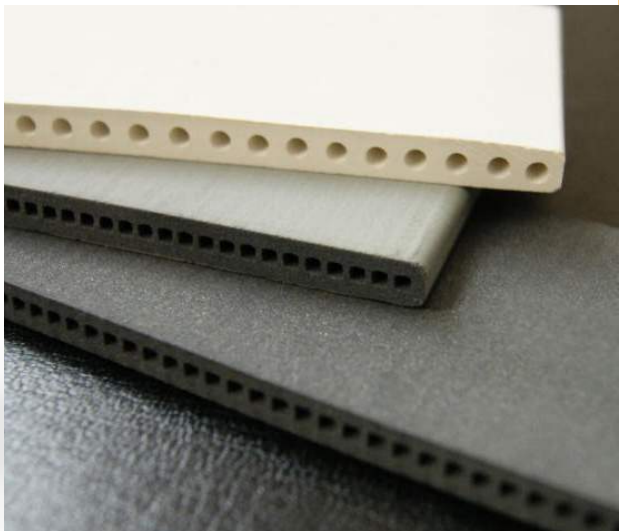

BUSINESS IMPACT

Identifying the shortcomings of akvoFloat (a hybrid water treatment process consisting of flotation and filtration) and their mitigation through Computational Analysis saves time and energy for plant optimisation. This results in lowering the price of the plant and reduces the capital investment needed by end users for new technology. Also, CFD can be used in adapting the plant to the type of the water, since every industry creates water of different qualities. Additionally, CFD-induced changes in the plant design reduce chemical and energy consumption and, in that way, reduce operational costs. These reductions translate into shorter payback times, which is the biggest driver for a sale. The increased expertise in the field of multiphase simulation, hydrodynamic simulations and simulation process design will help Navasto to showcase their competencies and capacities at conferences, trade fairs and on the company's website in order to increase the visibility of the company. This can be used to reach out to new customers and increase business. Potential end users are manufacturers of water treatment devices and companies that design or manufacture devices with complex internal.

BENEFITS

- The advanced hydrodynamic design of the wastewater-treatment plant increases the filtration efficiency by 20%.
- The smaller size of the plants and the reduced energy and chemical consumption shortens the time to positive return on investment.
- The development costs and development time for new products are reduced.



Earthquake resistant design using FE² technique

ORGANIZATIONS

EGIS INDUSTRIES is a French Consultancy firm undertaking civil engineering projects. STRAINS is a French SME specialized in the development of civil engineering software. It offers consultancy to a wide variety of clients. EPCC is a UK HPC centre at the University of Edinburgh.



End User



www.egis-group.com

ISV



www.strains.fr

HPC Provider



www.epcc.ed.ac.uk

THE CHALLENGE

Evaluating the reliability of civil engineering structures under extreme loads (earthquake, explosions, flooding, etc.) requires non-linear static and dynamic analyses. To be accurate, these analyses must pay attention to structural details which are more likely to contribute to failure. The demand for these kinds of analysis is increasing and is becoming mandatory. These analyses are mostly done by SMEs, but the computing resources needed to generate exploitable results within a reasonable time and cost clearly exceed in-house capabilities.

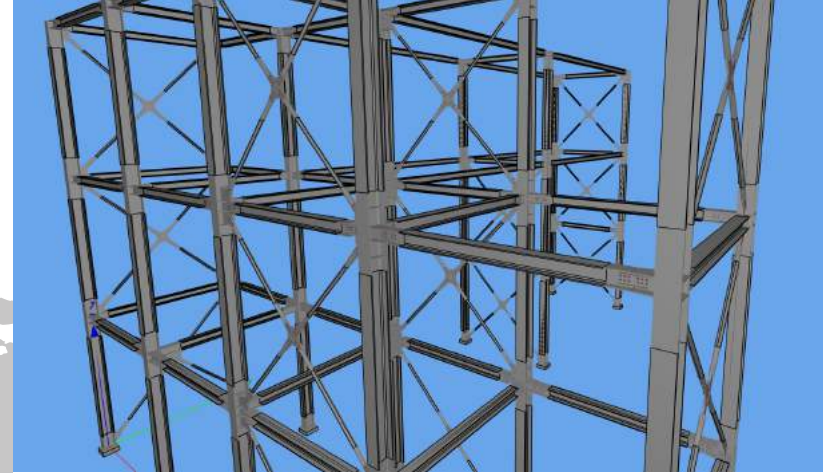
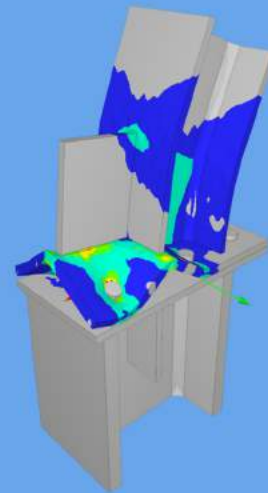
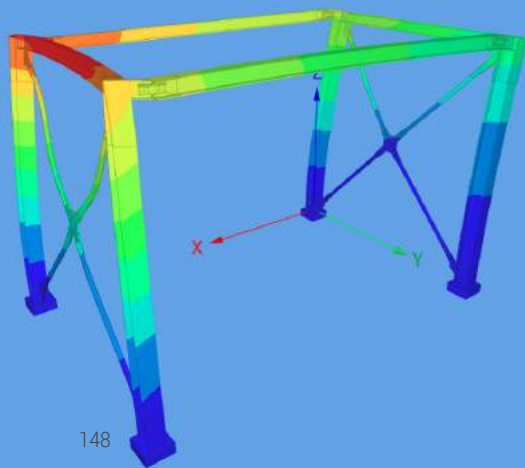

EXPERIMENT #902 HIGHLIGHTS

Industry Sector:
Civil engineering

Country: **France**

Software used:
Digital-Structure

THE SOLUTION

Digital-Structure is a cloud platform for structural analysis. The product was enhanced during the Fortissimo experiment to address non-linear dynamics involving the behaviour of non-linear materials and resultant friction. This product has a highly robust convergence in comparison with traditional Finite Element Software. The data structure is optimised for parallel computing: a local scale assesses the plastic behaviour of local steel joints and a global scale evaluates the dynamic behaviour of the structure. These computations require a huge amount of computing power. Since HPC infrastructure is expensive for SMEs, a Cloud-based solution on a pay-per-use basis offers the best way to control costs.

BUSINESS IMPACT

Using Digital-Structure with its CAD or data import tools, users can design a complete steel structure and its joints on the web platform. Improving the resistance and behaviour of the structure is easy: loads can be defined and elastic, elastoplastic, yield, and dynamic analyses can be launched even when a significant level of compute resources is needed. Digital-Structure significantly reduces engineering time thanks to fast computations, complete workflows (from CAD to building standards verifications) and a user-friendly interface dedicated to civil engineering. The software is very intuitive with no maintenance required (installations, updates, license, etc.). Computing times are much faster thanks to the use of HPC. The reduction in cost of designs for an SME is estimated to be between 40% and 60%. Overall these factors can double the productivity of an engineer. As a consequence, Digital-Structure enables users to optimise designs, determine finer and more accurate security margins and reduce environmental impact and production costs. Its use can result in a significant increase in the value of an SME's structural designs.

BENEFITS

- Engineers' productivity doubles using Digital-Structure.
- The value of consultancy projects increases by at least 20% thanks to finer security margins and optimised designs.
- Effective control of computing resource costs and risks.



Cloud-based multiphysics simulation for MEMS micro speaker design and development

ORGANIZATIONS

USOUND GMBH based in Graz, Austria, is a fast-growing audio company, developing and producing the most advanced audio systems for personal applications based on MEMS (Micro Electro Mechanical System) technology. HLRS is the High-Performance Computing Center Stuttgart of the University of Stuttgart in Germany.



End User & ISV



www.usound.com

HPC Provider



www.hlrs.de

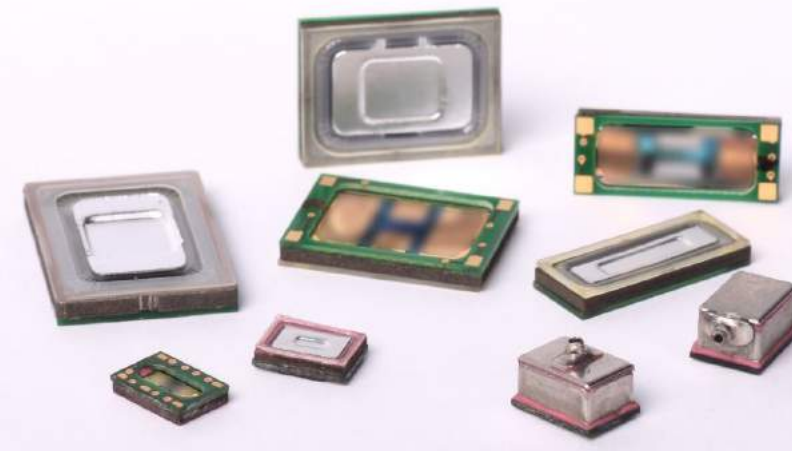

EXPERIMENT #903 HIGHLIGHTS

Industry Sector:
Electrical Engineering

Country: **Austria**

Software used:
COMSOL Multiphysics

THE CHALLENGE

USound GmbH develops unique MEMS miniature speakers based on the piezoelectric effect. Such speakers have all the advantages of MEMS technology; automated production and assembly, a smaller form factor, negligible heat generation and improved linearity compared to the classical loudspeaker. A MEMS production run is expensive and time consuming. Very powerful multi-physics simulation tools are needed as an alternative to physical prototypes to predict the acoustic performance of the speaker and to reduce the number of production runs needed.

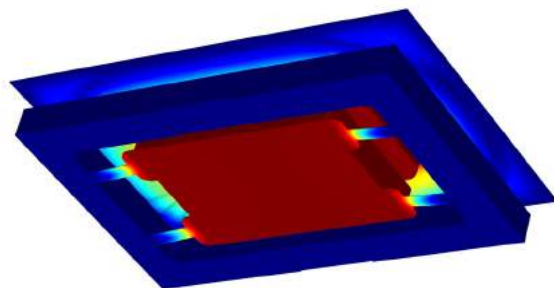

THE SOLUTION

The USound in-house multi-physics simulation, running on the commercial tool COMSOL Multiphysics, has been used to predict the Sound Pressure Level produced. This approach had restrictions and simplifications due to limited computational power available. The calculation time for this model is 10 to 20 hours, which slows down the development process and does not allow fast parameter variation. HPC offers the possibility to use a more detailed geometry without compromises, analyze and consider acoustical losses with thermos-viscous methods and speed the development process. The COMSOL Multiphysics tool was adapted to run on the HLRS cluster system directly over the native user interface.

BUSINESS IMPACT

USound is pioneering MEMS speakers. In the area of microphones, MEMS have replaced traditional microphones almost completely by now. USound is expecting the same to happen to micro-speakers. To address the mobile communications market, further technology and product development is needed. The development for the next-generation mobile speaker product will be 50% faster using the cluster computing methods developed in this experiment. It will therefore allow USound GmbH to gain market share and react to customer needs in a timely manner. In the growing sector of MEMS devices, powerful multi-physics simulations are mandatory because experimental evaluation is very expensive. As devices become more complex, all sorts of mechanical, electrical and thermal influences have to be considered. These lead to very demanding simulation models. MEMS developers are limited by their conventional workstations. The experiment shows that for a demanding FEM (Finite Element Method) MEMS model, COMSOL cluster computing offers a step forward in increasing the complexity and reducing computation times of the FEM model.

BENEFITS

- Ability to use highly detailed models in fast simulations.
- Using exact models, €400.000 can be saved by reducing the number of prototyping runs from 4 to 2 (one run is in the order of €200.000).
- Faster time to market by up to 1,5 years.



Improvement of the remote expert system based on software OTEA

ORGANIZATIONS

EcoMT, Spain, is an ICT company that develops and integrates remote control and monitoring of facilities. CESGA, Spain, is the centre for computing, high performance communications systems and advanced services. GOMPUTE, Sweden, a leading simulation and HPC solution provider. ITMATI, Spain, is a Technological Institute for Industrial Mathematics.



End User



www.ecomt.net

Application Expert



www.itmati.com

HPC Expert



www.cesga.es

HPC Provider



www.gompute.com

THE CHALLENGE

Heating and cooling account for a half of the EU's energy demand. New Heating, Ventilation and Air-conditioning machines produce huge amounts of data. A deterministic system with brute force conditions was applied to detect anomalies and reduce energy consumption in more than 3.000 installations worldwide, with 600.000 variables monitored resulting in 3 trillion records for 5 years. The challenge of this experiment was to replace the brute force solution with a superior machine learning (ML) model which is numerically intensive and needs HPC.

Heatmap
Correlation Matrix

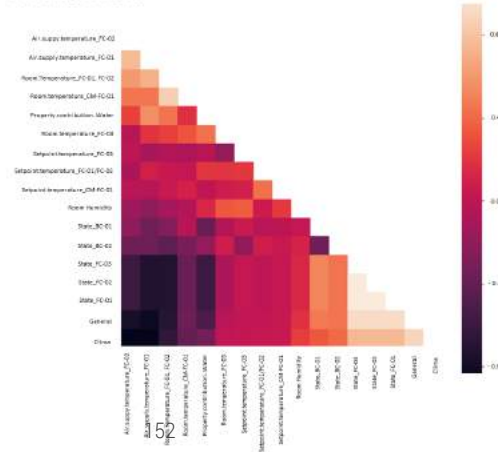

ALERTS										
Notes	country	Installation	Level	Activity	General pattern	Clima pattern	Machines	Risk	State	Graph
	Spain	5792	Level 1	🔴	100	100	All	75	👁️	📊
	Spain	12684	Level 1	🔴	100	100	All	75	👁️	📊
	Spain	11991	Level 1	🔴	100	100	All	75	👁️	📊
	Spain	5327	Level 1	🔴	100	100	All	75	👁️	📊
	Spain	1004	Level 1	🔴	85	100	All	72	NEW	📊
	Spain	604	Level 1	🔴	74	100	All	72	NEW	📊
	Spain	6432	Level 1	🔴	60	100	All	72	👁️	📊
	Spain	6432	Level 1	🔴	54	80	UTA-02, UTA-04	68	👁️	📊
	Spain	6432	Level 1	🔴	41	65	FC-01	65	👁️	📊
	Spain	7365	Level 2	🔴	10	15	All	72	👁️	📊
	Spain	7365	Level 2	🔴	7	15	CL-01, CL-02, CL-05	68	👁️	📊
	Spain	7365	Level 2	🔴	5	10	FC-03	65	👁️	📊
	Spain	105	Level 3	🔴	39	45	-	72	👁️	📊
	Spain	9016	Level 3	🔴	27	30	-	72	👁️	📊

ALERT LEVELS					Anticipation of different types of incidents	
Daily diagnosis ☀️		Behavior pattern	Machines	Risk	Unusual consumption ENERGY EFFICIENCY	Lack of comfort ANOMALIES IN CLIMATE EQUIPMENT
LEVEL 1	High danger	✖️	✖️	✖️	📉	🐷
LEVEL 2	Medium danger	✔️	✔️	✖️	↕️	🐷
LEVEL 3	Low danger	✖️	✖️	✔️	↕️	🐷
LEVEL 4	Minimal danger	✔️	✔️	✔️	↕️	🐷
Night diagnosis 🌙		General consumption	Climate consumption	Operation mode Manual		
LEVEL 5	Maximum danger	✖️	✖️	Consumption of lighting and climate Only climate consumption		
LEVEL 6	High danger	✖️	✔️	Only lighting consumption		

EXPERIMENT #904 HIGHLIGHTS

Industry Sector: Energy

Country: Spain

Software used: Cassandra, R, In house code

THE SOLUTION

EcoMT's intention is to address maintenance management by using ML, through the analysis and processing of data from hundreds of devices and field sensors. This enables the anticipation of failures and the scheduling of predictive maintenance. These lead to the optimization of processes, the minimisation of downtime and costs and the more efficient use of energy. Due to these needs, the OTEA remote expert system (OTEAres) was developed as an expert remote management system with an aim for energy optimization through the premature detection of incidents based on historical records. HPC infrastructures offer the required capabilities to support these services and to provide scalable resources when required.

BUSINESS IMPACT

The savings of clients connected to the OTEAres platform, would be immediate, it enables decision support in real time offering a 24/7 service through its control centre, which is the department in charge of controlling the proper functioning of the installations, remotely resolving incidents in the shortest time possible.

The previous version is updated into a new ML model capable of predicting and organising a wider range of incidents. It is estimated an energy saving of 7% per installation, a reduction of 30% in preventive maintenance visits and a reduction of 20% in corrective maintenance.

More than 20% of the incidents registered could be corrected remotely without the need for a technician. Predictive maintenance will prolong the life of customers' HVAC machines and reduce the number that need to be replaced. EcoMT expects to double the number of controlled facilities in the short term by extending this service to all actual connected installations and to quadruple this number in the long term, with an estimation to produce 1 million euros of total annual revenue.

BENEFITS

- EcoMT clients can expect to save up to 7% on their electricity bills.
- Implementation of control panels in other facilities, with an estimation of €15 million of revenue in 5 years.
- Managing current installations with OTEAres doubles the annual income to EcoMT.



Digester 2.0: Optimization of the anaerobic digestion process for biogas generation



ORGANIZATIONS

NORVENTO is a company focused on renewable energies and manufacturing of wind turbines. ENERGYLAB is a Spanish (non-profit) private technology centre. UNIVERSITY OF MINHO is Application Expert and CESGA from Spain is the HPC Provider.

End User



www.norvento.com

Domain Expert



www.energylab.es

Application Expert



www.uminho.pt

HPC Provider



www.cesga.es

THE CHALLENGE

Anaerobic Digestion is the process by which microorganisms degrade organic matter in the absence of oxygen, producing a methane-rich biogas stream that can be used for energy generation. Industrially this process takes place in large full tanks called anaerobic digesters. The development of a computational modelling solution to simulate digesters and support the design and optimization of the energy balance was seen as a potential solution to the development of advanced digesters.

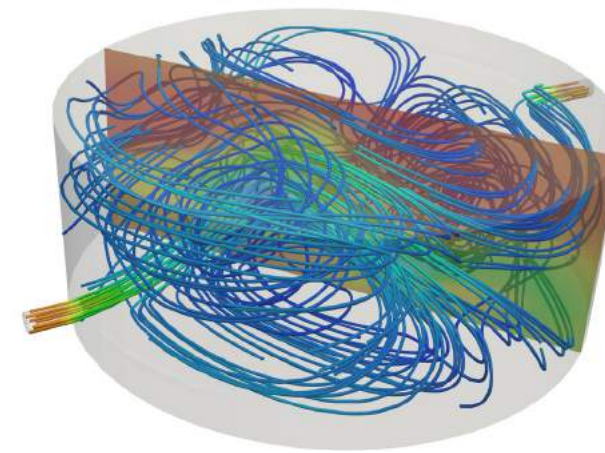

EXPERIMENT #905 HIGHLIGHTS

Industry Sector: Energy

Country: Spain

Software used: OpenFOAM

THE SOLUTION

Before this experiment, there was no integrated model for the design of anaerobic digesters considering flow and biological aspects, able to take advantage of HPC systems. A new open-source based solution that allows the simulation of flow (fluid dynamics) and biological aspects of an anaerobic digester was developed. Due to the scales involved in the process (300 m³ for anaerobic digester and particles around 0,01 cm³), the numerical solution of this coupled problem is very complex. Highly refined meshes are needed, which results in large computation times. Consequently, the solution requires HPC to provide results in an affordable time which model the engineering processes.

BUSINESS IMPACT

Developed tools allow Norvento to reduce volume and cost of industrial anaerobic digesters, increasing the amount and quality of the produced biogas while reducing the energy consumption. As a result, Norvento renewable energy power plants are able to increase their electrical and thermal production. For Norvento, a cost reduction in investment and maintenance as a direct outcome of reduced size digesters, will improve and support a profitable and sustainable business, and favour new business lines, such as the implementation of on-site digesters for cattle raising installations. EnergyLab obtained a valuable knowledge of fluid-dynamics, HPC and simulation models. Potentially, new services focused on energy efficiency, based on the HPC simulation tools developed, can be set up and included in the EnergyLab service portfolio. The University of Minho developed the simulation solver based on OpenFOAM and acquired valuable insights in a completely new area for them: the simulation of processes involving chemical reactions. The knowledge obtained and the developed tools may be relevant for other industrial applications.

BENEFITS

- 5% increase of thermal and electrical production of Norvento's biogas plants.
- More efficient digesters will contribute to the reduction of greenhouse gas emissions.
- New services in the EnergyLab portfolio and growth expected by 30% in total sales.



Cross-solver Cloud-based tool for aeronautical FSI applications



ORGANIZATIONS

RINA CONSULTING SPA is an Italian engineering consulting company providing high-quality tailored solutions. University of Rome and the National Technical University of Athens provided expertise in numerical optimization and mesh morphing. CNR, the largest public research organization in Italy, provided expertise in cloud technology, with the IAC research group. CINECA is an HPC provider and host centre.

End User	HPC & Application Expert	Application Expert	HPC Provider
www.rina.org	www.cnr.it	www.epu.ntua.gr	www.hpc.cineca.it

THE CHALLENGE

For an aircraft production cycle, the ability to reduce production costs decreases rapidly during the first phases of the project. In fact, 80% of the development cost and 70% of the life cycle cost of a product are determined during its conceptual design phase. Considering this, the need to reduce the research and development (R&D) investigation time is significant. Consequently, powerful design tools are essential to shorten the time to acquire physical knowledge about the aircraft components and so to reduce production costs.

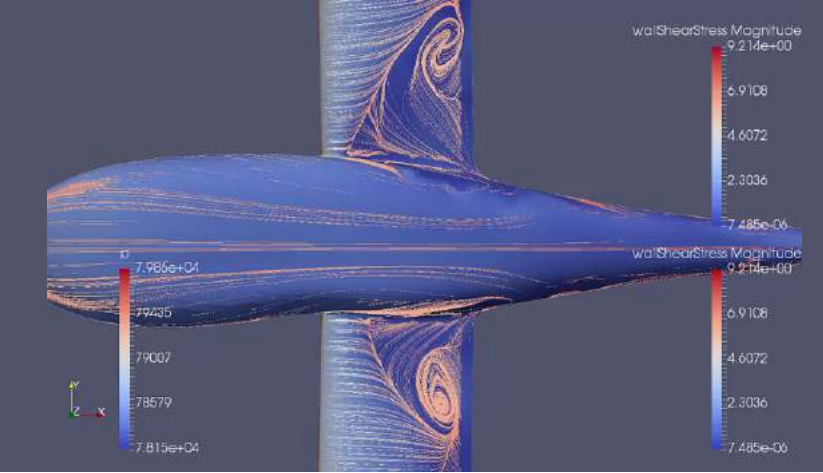
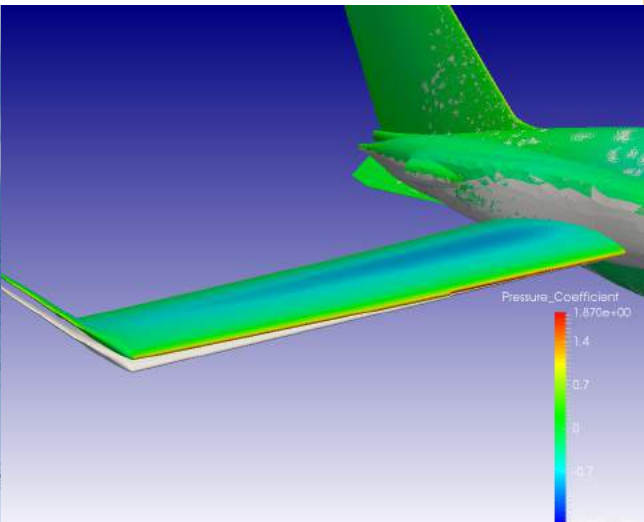
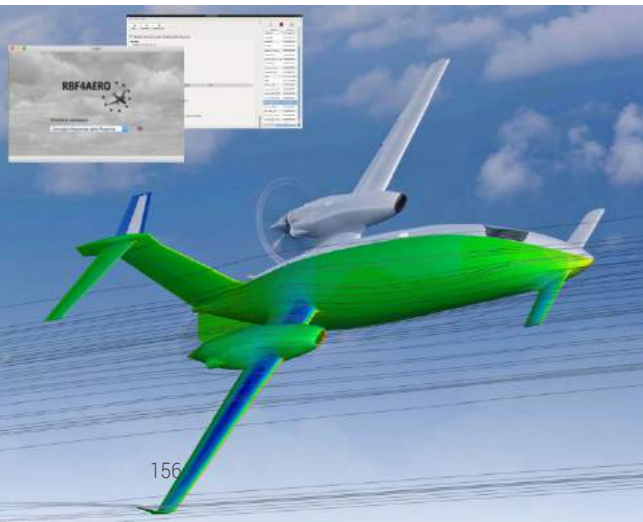

EXPERIMENT #906 HIGHLIGHTS

Industry Sector: **Aerospace**

Country: **Italy**

Software used: **SU2, RBF Morph, OpenFOAM**

THE SOLUTION

The RBF4AERO platform is a toolbox which tackles all the aspects related to aircraft numerical design and optimization. It does this by making the CFD model parametric through an innovative shape optimization tool based on a high-performance meshless morphing technique.

The experiment performed the successful adaptation of the RBF4AERO platform to work on Cloud-based HPC. This adaptation was applied to the optimization of a component of a real aircraft using computational models relevant to the aeronautical sector. The Consortium benefitted from the technical collaboration with Piaggio Aerospace, which provided the models to set-up the optimization of the shape of the P180 Avanti EVO vehicle.

BUSINESS IMPACT

Improving aircraft performance has a clear economic value. In this experiment the RBF4AERO platform was used on an industrial case demonstrating its capability to solve a wide range of real world aeronautical aero-elastic optimizations in a reliable and cost-efficient manner. This achievement was realised through the generation of a computational mesh aligned with the requirements dictated by a worldwide mid-size business jets stakeholder, the generation of consistent shape modifications of industrial significance and the demonstration of the feasibility of a fully coupled fluid-structure interaction computation with CAE models characterised by non-matching external surfaces.

RINA CONSULTING estimates an increased turnover of €100.000 one year after the finalization of the experiment and a total accumulated of at least €400.000 over three years. RINA estimates an increase of at least 2 qualified jobs over three years. The service will allow RINA to lower its current hourly rate by up to 10% and so reach new clients. NTUA estimates an increase by 5% in the revenues coming from FSI related projects in the next three years.

BENEFITS

- RINA CONSULTING estimates an increased turnover of €100.000 one year after the finalization of the experiment.
- The service will allow RINA to lower its current hourly rate by up to 10%.
- NTUA estimates an increase by 5% in the revenues.



Large-scale indie gaming analytics (LIGA)

ORGANIZATIONS

KUMO is a design, engineering, and innovation-led SME applying disruptive technologies across both hardware and software in the areas of 3D technologies and digital asset creation and management. CNR is the largest public research organization in Italy and a top-level R&D performer in Europe. CINECA is the HPC provider and host centre.



End User



www.3dkumo.com

Domain Expert



Consiglio Nazionale delle Ricerche
www.cnr.it

HPC Provider



www.hpc.cineca.it

THE CHALLENGE

The videogaming market is a complex arena with an increasingly crowded marketplace where dozens of games are released every day. The motivation for this experiment is that exploiting the huge amount of data available in gaming web portals and social networks may lead to value added services for the benefit of game developers that need to understand market trends, and to companies targeting gamers. KUMO, end user in this experiment, is interested in particular in increasing its penetration into the gaming-related market, with a focus on 3D printable models.

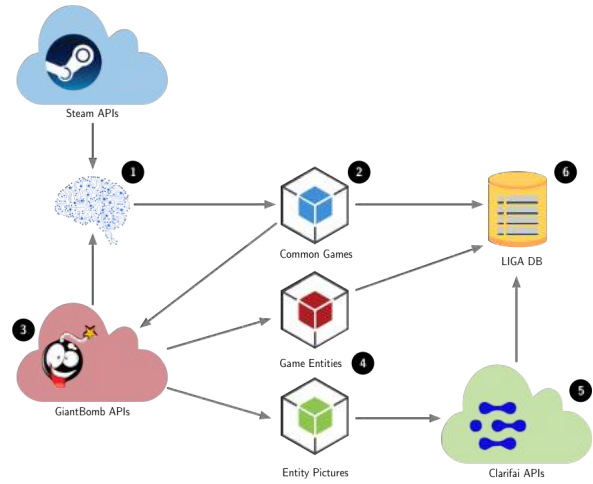
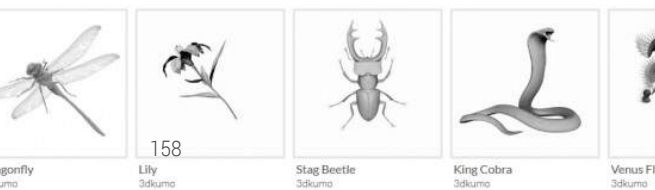

THE SOLUTION

LIGA has provided KUMO with two advanced services: Smart Retail Recommendation Engine (REC-ENG), that analyse user preferences and activities and 3D Content Analytics Services & Dashboard (3D-DASH) that allows content providers and game developers to understand better trends in games. LIGA helps KUMO to meet its goals by monitoring the popularity of game entities on social networks. Currently, LIGA infers entities' popularity by hourly monitoring of STEAM, a digital distribution platform which offers online multiplayer gaming. At the end of July 2018, LIGA stored 25 million entries in its database, describing the popularity of game entities among players. HPC techniques are needed to store and process efficiently this huge amount of data in a timely manner.

BUSINESS IMPACT

The Smart Retail Recommendation Engine REC-ENG is meant mainly for internal KUMO use. The main benefit for the customers of KUMO making use of REC-ENG is that the new tool will support their decision-making process in terms of models to be collected and shared. The tool will reinforce the links between models and users' likes, and also among models themselves.

The 3D Content Analytics Services & Dashboard 3D-DASH is meant both for internal use and as a service to be sold to videogame-producing brands. The main benefit for the brands customers of KUMO making use of 3D-DASH is that the new tool will support their decision-making process in terms of designing or characterising new models and 3D characters in their games.

The experiment will also help KUMO to expand in other sectors interested in or dealing with 3D models, like engineering (automotive, energy, etc.), culture (museums, artists, etc.), multimedia (animation, film producers, etc.).

EXPERIMENT #907 HIGHLIGHTS

Industry Sector: **Data Analytics**
Country: **Spain**
Software used: **In house code**

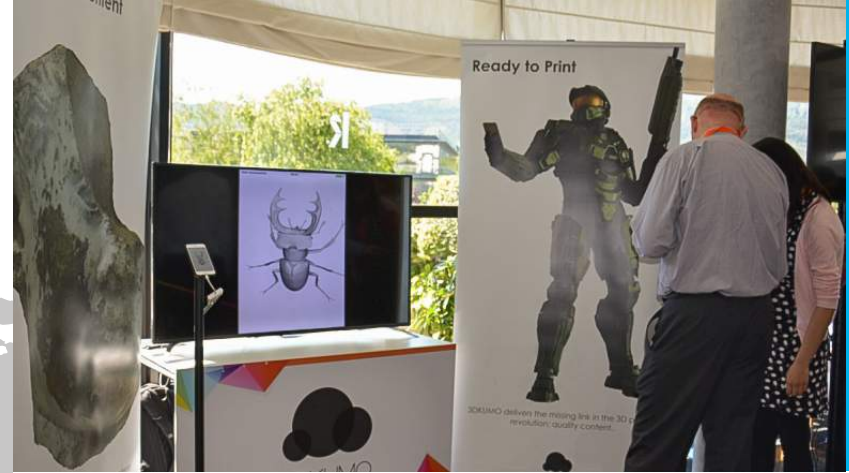

BENEFITS

- Increased KUMO turnover in the range of 75.000 - 150.000€ per year.
- Approximately 10% of yearly growth rate in next 2 years.
- Increased number of technological transfer contracts of CNR.
- New customers in the HPDA market for CINECA.



Massively parallel virtual testing of safety-relevant driving systems

ORGANIZATIONS

SPICETECH GMBH focuses on data-centric IT solutions, machine learning and data science. XLAB d.o.o. is focusing on distributed systems, Cloud computing, information visualization and image processing. HLRS is the HPC centre of the University of Stuttgart, Germany, and was the HPC provider in this experiment.



End User & ISV

HPC Expert

HPC Provider



www.spicetech.de

www.xlab.si

www.hlrs.de

THE CHALLENGE

Various branches of the high-technology industry are experiencing strong increase in the complexity of their products. In particular, for products and systems, which act autonomously in safety-critical environments, e.g. for autonomous cars in urban traffic scenarios, the cost for validation and certification is rising sharply. Virtual validation will be a key methodology to face such challenges, due to the fact that enormous amounts of test cases must be considered covering a huge testing and validation space.

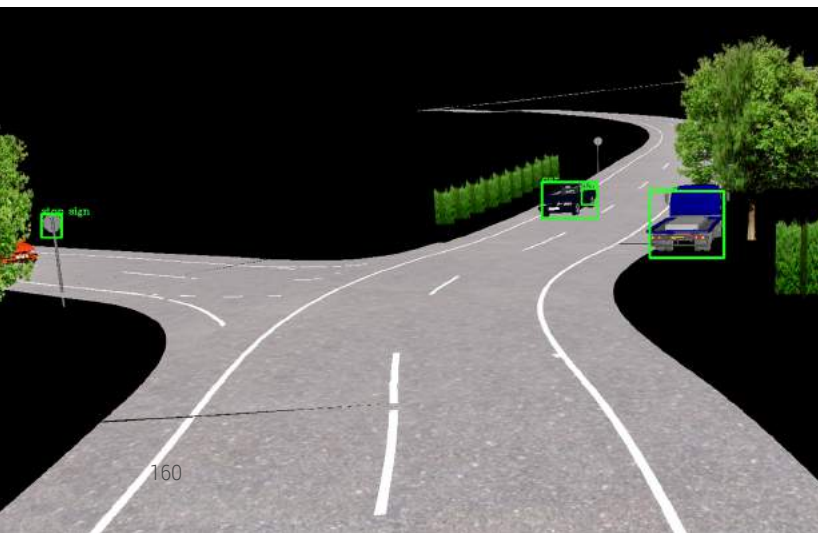

EXPERIMENT #908 HIGHLIGHTS

Industry Sector: **Automotive**
Country: **Germany**
Software used: **OpenDrive, TensorFlow, OpenScenario, OpenCV**

THE SOLUTION

Test and validation aspects will have to be solved in multi-dimensional parameter spaces. The proposed approach allows the user to freely choose dimensions and parameter-spaces, which describe the test scenarios. For example, for a car arriving at a road intersection, a potential validation task would be to ensure a correct classification of objects (cars, pedestrians) interacting at the intersection. Just positioning them and adjusting their speeds yields 10-15 dimensions of test space. The VALICY framework uses High-Performance Computing (HPC) and Artificial Intelligence (AI) in order to quickly scan these dimensions for object classification errors.

BUSINESS IMPACT

The VALICY framework, developed in the course of this experiment, offers the opportunity to integrate a highly complex virtual test and validation task into the product development process. VALICY can be integrated into classical milestone-based development but, more interestingly, into iterative and incremental processes. Hence, high opportunities for fast test and validation feedback arise in fields, where software and hardware development move forward together.

The proposed approach samples high-dimensional test spaces efficiently, due to distributed parallel computations. Furthermore, the Machine Learning (ML) component ensures that after a short period of adjustments to identify critical cases, only the scenarios that ML expects to be of high relevance are tested and validated.

The VALICY framework is valuable for industry sectors that struggle, not only with high system complexity but also with new norms and regulations. Appropriately designed test and validation spaces can be created to support early and rapid knowledge of the certification process over a broad range of variations.

BENEFITS

- Parameter variation runs can include 10-15 testing dimensions.
- Thousands of validation runs can run in parallel by using HPC processing power.
- VALICY decreases the validation cost by an estimated factor of hundred.



The Virtual Engineer 2 – Cloud-based optimisation of production in the dairy sector

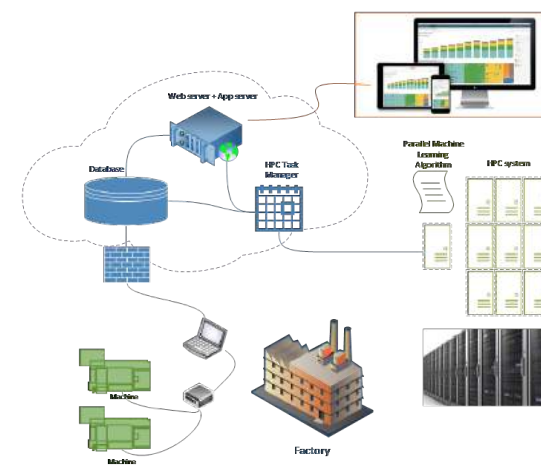

EXPERIMENT #909 HIGHLIGHTS
Industry Sector: **Food Manufacturing**
Country: **United Kingdom**
Software used: **The Virtual Engineer #2 using MATLAB**

ORGANIZATIONS

MOODY DIRECT is a British SME that manufactures bespoke components both manually and with the latest CNC machinery to support servicing of OEM machines in a range of industries. THE UNIVERSITY OF PORTSMOUTH was the domain expert in this experiment. EPCC provided HPC resources and expertise.

End User



www.moodydirect.com

Application Expert



www.port.ac.uk

HPC Provider



www.epcc.ed.ac.uk

THE CHALLENGE

The Dairy industry is a low-margin, high turnover industry. Each machine can break down up to 3-5 times per year with a breakdown lasting up to 6 days at a time, and penalty fines can cost the customer up to €380,000 per day. Moody Direct delivers a maintenance service into production sites. Current predictive maintenance measures are not comprehensive and not multi-machine, multi-site. Moody wants to offer enhanced Service Agreements with UK customers to reduce downtime and achieve increased sales through supply and manufacture of spares.

BUSINESS IMPACT

Moody Direct now has access to a working online platform that gives an oversight of the machines at the Müller site. Currently the system is only streaming data from 1 machine, but there are 3 other machines onsite that can in future share their data with the online platform. Moody Direct can offer an enhanced service-based business model which is anticipated to bring better management of the scheduling of engineers and control of stocks of spare parts. The platform will also improve the capability and knowledge of the Engineers and increase their productivity as a result.

For Müller, the benefits are increased productivity and energy minimisation due to improved machine health. There will also be a reduction in food waste as machines continue to run successfully without the need to dispose of lost milk during machine failure.

For the University of Portsmouth, the experiment has led to the generation and transfer of knowledge within its Operational Research and Artificial Intelligence academic community and an improved knowledge of big data analytics and parallel processing through HPC.

BENEFITS

- Savings for dairy manufacturers in excess of €50 million as penalty fines are avoided.
- Increased productivity of approximately 200,000 bottles per machine per year.
- Reduction in environmental contamination and food waste, up to 200,000 bottles of milk saved from disposal per machine.





OptiBike robust lightweight composite bicycle design and optimization

ORGANIZATIONS

IDEC is an SME, focused in composites and new materials. Its main strength is the development and industrialization of Advanced Composite Structures. UNITO is an Italian university from Turin, that provided HPC expertise together with NOESIS, who is also an engineering partner. ARCTUR, the Slovenian HPC centre, is an HPC Provider.



End User



www.idec.aero

HPC Expert



www.noesisolutions.com



www.en.unito.it

HPC Provider



www.arctur.si

THE CHALLENGE

Composite structures, especially those incorporating carbon fibres, are much more complex than isotropic metal alloys, as they require lengthy development, significant knowledge and fine tuning. Building prototypes to test various configurations may take years to reach an optimal structure. Numerical simulations significantly reduce the time and effort required, but modelling software tools and HPC infrastructures represent a large investment and solving optimization problems with hundreds of parameters require highly skilled engineers.

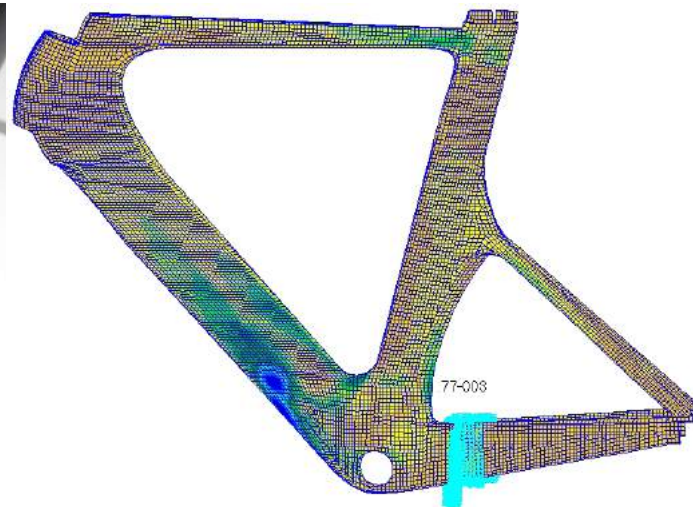

EXPERIMENT #910 HIGHLIGHTS

Industry Sector: **Manufacturing**
Country: **Spain**
Software used: **Optimus, Code_Aster, MxNet**

THE SOLUTION

The experiment focuses on providing SMEs with a user-friendly service to optimize the configuration of the layers of a composite material part, returning, in a reasonable timeframe, the best performing orientation of the layers, that respects manufacturing constraints. In order to speed up the process, this service is deployed on an HPC Cloud infrastructure and it leverages machine learning algorithms to exploit and enhance the expert's knowledge about performance and manufacturability. Once defined the best-performing configuration, the service is able to analyse the robustness of the optimal design. The approach is validated on a use case that involves the simulation of stresses and deformations on a composite bike frame.

BUSINESS IMPACT

The solution leads to a reduction of 80% in the time to design and optimise a bicycle that can currently take up to 8 months. In addition, it reduces the number of the manufactured prototypes by 75%. Having this optimization workflow available, means that IDEC is capable of staying ahead of the competition despite its limited resources. This is particularly relevant in volatile sectors such as competition bike manufacture. The reduced development time, will also allow IDEC to react more quickly to modifications of the design.

On the other hand, Noesis will be able to provide this composite optimization service to customers looking for a general-purpose solution for their composite parts. Moreover, the methodology on which the service is based, enriches Noesis' offer of engineering services and is meant to attract customers that are looking for a tailored solution for very high-end composite parts. Presence in the Fortissimo Marketplace will allow Noesis to reach out to a number of customers that are not yet in its sales network.

BENEFITS

- The end user has reduced the development time by 80% and number of physical prototypes by 75%.
- €45.000 saved by the end user per bike frame model.
- 9 new customers expected by the end user within 5 years after the end of the project.



EXPERIMENT #911 HIGHLIGHTS

Industry Sector:
Automotive

Country: **Slovenia**

Software used:
Altair Flux, GNU Octave, Altair Hyperworks

HPC Cloud-based simulation of coupled electromagnetic and structural-acoustics in in-wheel electric motors

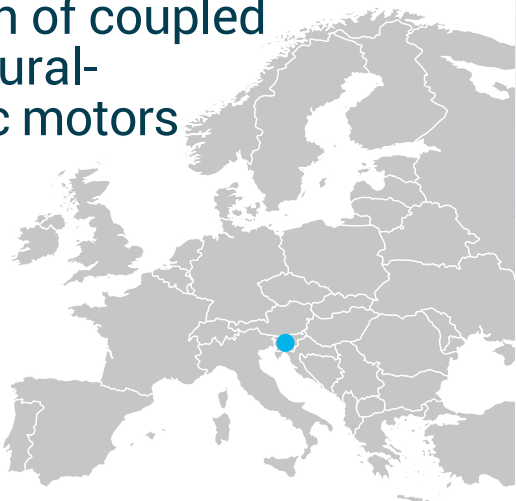

ORGANIZATIONS

ELAPHE PROPULSION TECHNOLOGIES LTD is a Slovenian SME. It is among the most experienced companies in the field of development of in-wheel motors for electric and hybrid vehicles. CINECA is participating as an HPC provider and host centre in this experiment.

End User



www.in-wheel.com

HPC Provider



www.hpc.cineca.it

THE CHALLENGE

Despite delivering several benefits, the unsprung electric in-wheel propulsion technology is still being considered as inferior to chassis mounted electric propulsion. This is true in particular for design process issues related to the optimisation of noise, vibration and harshness (NVH) characteristics, where complying to EU regulation No. 540/2014 on the sound level of motor vehicles is crucial obtaining an optimized NVH-acceptable design for the product's industrialized version is also critical to reach a production process with less physical prototype assembly and measurement.

THE SOLUTION

The main result of this experiment is the workflow developed for an optimization and automated coupled multiphysics computation of a detailed acoustic noise map of in-wheel motors which was developed from scratch. This new methodology, which benefited from the Cloud-based HPC was implemented and evaluated on the next-generation prototype of Elaphe M700 and L1500 in-wheel motors. The overall noise level of the motors improved by a minimum of 20 dB(A) and up to 60 dB(A) over the whole in-wheel motor operating range.

BUSINESS IMPACT

The market preference for green products is growing and environmental policies are increasingly in favour of sustainable, highly-efficient electric propulsion. With lower noise levels, electric vehicles will improve the urban soundscape for many people, mitigating sound pollution at all hours. On the other hand, lighter weight and the race for efficiency improvements under strict conditions is driving an increase in the efforts of vehicle designers and manufacture in studying different vehicle concepts, with NVH characteristics being one of the most important aspects. A holistic approach requiring coupled electromagnetic (EM) and structural-acoustic (SA) simulations is necessary to optimize sound levels while preserving the required performance and other imposed design features. During this experiment, the use of HPC substantially decreased the simulation time and improved the quality of obtained results. This resulted in a substantially reduced development cycle. The process was completed 10-times faster and at the same time enabled more complex simulations, directly resulting in improved products for Elaphe.

BENEFITS

- Estimated yearly savings of €120.000-€150.000 for end user in development/design process.
- End user expects also up to 80% shorter time-to-market and at least 80% faster introduction of NVH-related improvements to products.
- The optimized design is expected to increase Elaphe sales by 20%.





Multiphysics icing analysis using HPC Cloud



EXPERIMENT #912 HIGHLIGHTS
Industry Sector: **Aeronautical**
Country: **Germany**
Software used: **UderEis**



ORGANIZATIONS

MT PROPELLER is a German SME and a leading manufacturer of propellers for small aircraft. NORTHERN NUMERICS LTD is a UK SME specializing in simulations of freezing phenomena for the aeronautical, automotive, naval, construction and process industries. ARCTUR is a Slovenian SME, participating as an HPC provider.



THE CHALLENGE

MT Propeller aims to improve the design of ice protection systems for its propellers, shorten simulation times from one week to less than a day. This allows MT Propeller to incorporate the ice accretion simulations more efficiently in its design cycles. Increased computational resources through HPC uptake would allow MT Propeller to design more complex propellers for larger aircraft and analyse ice protection systems performance as installed on the aircraft.

THE SOLUTION

The Northern Numerics UderEis software offers some of the most advanced physical models for simulating ice accretion on aircraft components. UderEis is HPC capable and cut down the MT Propeller simulation times to less than a day. UderEis also allowed the simulation of ice accretion on rotating propellers. Using the computational resources of the Arctur HPC Cloud it was possible to perform ice accretion analysis on a rotating propeller as installed on a small aircraft. A user-friendly GUI was developed, with detailed online tutorials for prospective users of UderEis to facilitate software adoption. The UderEis on-demand flexible licensing scheme is very competitive compared to licensing schemes of larger vendors.

BUSINESS IMPACT

The dramatic reduction of ice accretion simulation times and the ability to analyse ice protection system performance on rotating propellers as installed on aircraft increase the reliability of the ice protection system and result in multiples of €10.000 savings for MT Propeller. The shorter turnaround times on HPC platforms and correspondingly more efficient design cycles lead to a substantial reduction in the labour costs for design. Moreover, the new ability to analyse larger and more complex cases for larger aircraft allow MT Propeller to explore a new market and potentially increase their sales. As for Northern Numerics, the availability of its products on the Fortissimo Marketplace and increased visibility will allow it to attract more business. Northern Numerics conservatively expects to double its sales volume. Both MT Propeller and Northern Numerics benefit from outsourcing computational resources and management to the Fortissimo Cloud on demand, with corresponding savings in the higher margin. Arctur aims to increase its SAAS and PAAS sales by offering a new product in its portfolio, with annual sales increase.

BENEFITS

- Reduced costs for simulations of multiple €10.000.
- Reduced simulation times from one week to less than a day.
- Use of much more realistic physical models by the end user.
- Reduced HPC costs for the HPC expert by outsourcing computational resources to the Cloud.

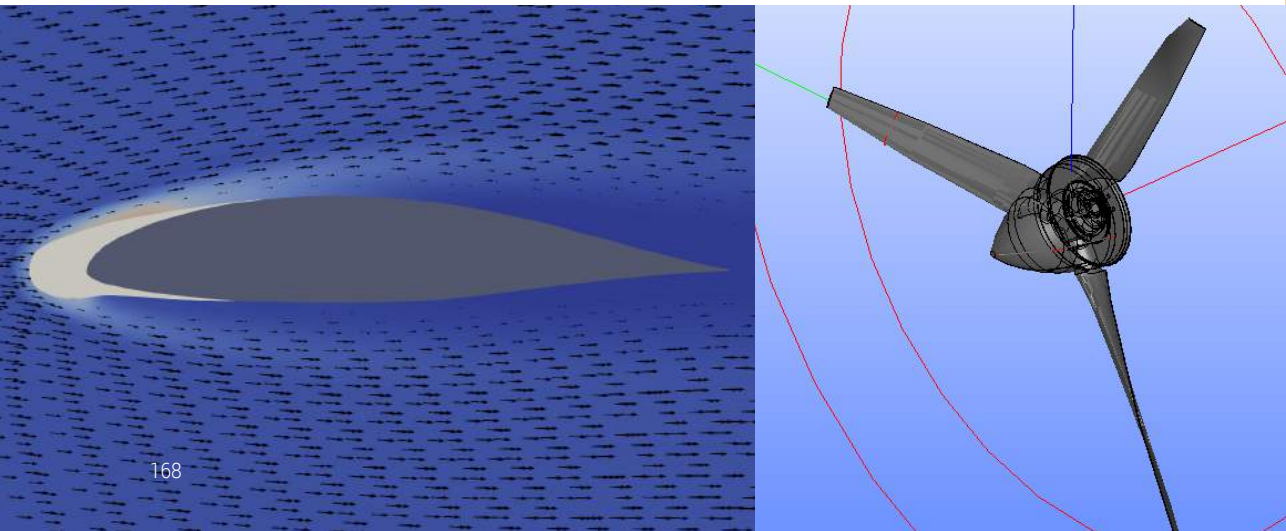



Cloud-based multiphysics simulation for designing highly dynamic and highly accurate flow controls for microfluidic applications

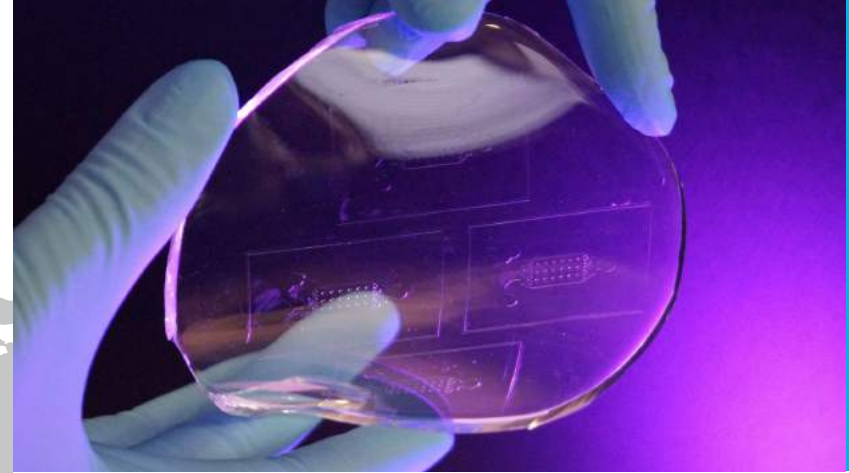

EXPERIMENT #913 HIGHLIGHTS
Industry Sector: **Microfluidics**
Country: **France**
Software used: **OpenFOAM, OpenModelica**

ORGANIZATIONS

ELVESYS, from France, is an SME that commercializes the world's widest brand of microfluidic flow control products. GOMPUTE, from Sweden, is a leading simulation and HPC solution provider. ITAINNOVA from Spain, is a public non-profit Technology Centre, working in innovation and technological development.

<p>End User</p>  <p>www.elveflow.com</p>	<p>ISV & Application Expert</p>  <p>www.itainnova.es</p>	<p>HPC Provider & Expert</p>  <p>www.gompute.com</p>
---	---	--

THE CHALLENGE

Microfluidics is both the science that studies the behaviour of fluids through sub-millimetre micro-channels, and the technology for manufacturing its components. The control of complicated as the chips are sensitive to external variations; systems have dead fluid volumes slowing down the reaction time; and the most convenient sensors are not always available. The experiment aims to generate real-time computer simulation that mimics the physical device in order to allow the best dynamic controllability, both in models and real world.

THE SOLUTION

The solution is based on the development of simulation models that can be used both for testing the virtual system and for controlling the real one. These models are used in two ways: as advanced control strategies to anticipate the behaviour of the system, mitigating the effect of sensitivity and dead volumes and as a soft sensor, providing flow characteristics not available by sensing, such as flow depths, interface location or shear stresses. The development must involve HPC for Computational Fluid Dynamics (CFD) simulations of the microfluidic chip in service. Batches of CFD simulations need to be run in the cluster to build real-time simulation tools based on Reduced Order Models (ROMs).

BUSINESS IMPACT

The main business achievement is a methodology to develop accurate model-predictive-control strategies in virtual and real microfluidics systems. The information provided by the simulation workflow will allow a continuous improvement of the value chain. Elvesys will offer easy access to microfluidics simulation for their customers by a Cloud-based virtual lab that will facilitate the selection and purchase of microfluidic devices. Also, Elvesys gets a deep insight into the performance of the products at a component and system level. An improvement from 5 to 10% of the profit margin per offer and access to a greater share of the Total Addressable Market (TAM) (projected to reach \$112 billion by 2023) are expected. ITAINNOVA will enhance and renew the portfolio of services for its clients. It demonstrated the impact of real-time simulation tools on manufacturing sectors beyond this experiment. Itainnova will offer s development of new similar simulation procedures as a consultancy service for SMEs, focusing on mechatronic setups.

BENEFITS

- Improved presales argumentation yielding a 10% yearly increase in pressure controller sales.
- Reduce the presale cost associated with device lending and demonstration.
- Reduce the discounts thanks to increased understanding of the product line.

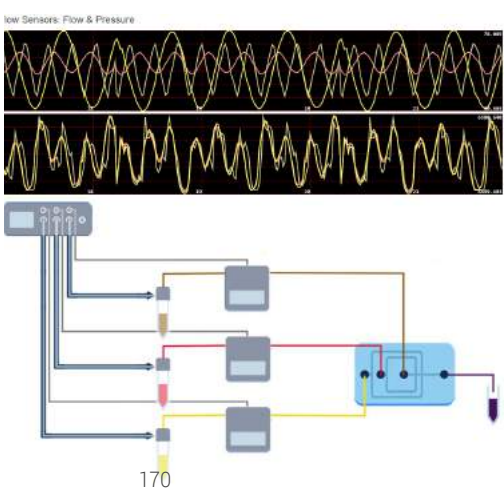

Experimental (Elvesys)



CFD (ITAINNOVA)

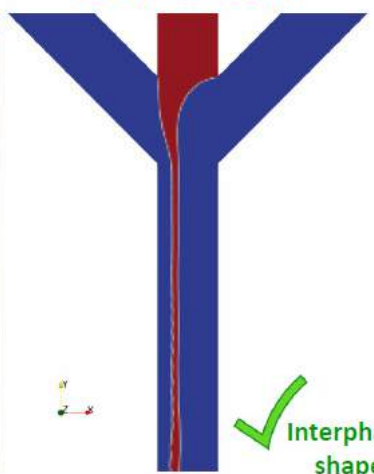

Interphase shape



HemoSphere – Prototyping of blood-processing microfluidics in the HPC Cloud



EXPERIMENT #914 HIGHLIGHTS

Industry Sector: **Microfluidics**
Country: **France**
Software used: **HemoSphere**

ORGANIZATIONS

AENITIS TECHNOLOGIES S.A.S. is a French microfluidic company that is developing a blood sorting device. ELECTRIC ANT LAB B.V. is a Dutch software company that specialises in complex fluid simulations. SURFSARA is the operating company for the Dutch national super computer, HPC centre Cartesius.



End User



www.aenitis.fr

ISV



www.electricant.com

HPC Provider



www.surfsara.nl

THE CHALLENGE

Electric Ant Lab (EAL) has developed HemoSphere for the detailed simulation of complex fluids. This technology can be applied to prototyping microfluidic chips. The microfluidics industry is a young medical technology and equipment field where small-scale phenomena are difficult to observe. In this field there is a large demand for more cost-effective and methods as opposed to trial-and-error process for prototyping new chips. The challenge was to replicate the behaviour and small-scale phenomena of an acoustophoresis chip into a browser-based simulation tool.

THE SOLUTION

A simulation model of the microfluid device of Aenitis was developed which is much truer to reality than previously used models. This was achieved by explicitly incorporating the generation of a soundwave in the system. Rather than assuming that the soundwave induces certain forces, the model allows the acoustic forces to develop naturally from the interaction of the soundwave with the particles (blood cells) present in the microfluidic channel. In this way, more insight and understanding of the processes in the microfluidics device could be generated.

BUSINESS IMPACT

The use of simulations in the development of acoustophoretic microfluid devices as developed at Aenitis can significantly reduce development costs. In the laboratory, a single microfluidics geometry needs to undergo a large series of tests to assess its performance. With the same approach in HemoSphere, these development iterations can be run faster. More information about the fluid behaviour will also be generated, as these phenomena are not easy to research visually. In the laboratory only one experiment iteration at the same time can be achieved. In HemoSphere multiple experiments can be executed at the same time.

For microfluidic companies this approach can create a tremendous impact on the time spent in the development and prototyping stage of the microfluidic chip design process. It also requires less resources in terms of produced physical prototypes and the usage of human blood samples.

BENEFITS

- Savings between 20.000€ and 25.000€ for a single prototype.
- Time saving: experiments in the physical lab can take about 4-6 months, where the virtual experiments can be performed in a matter of days or weeks.

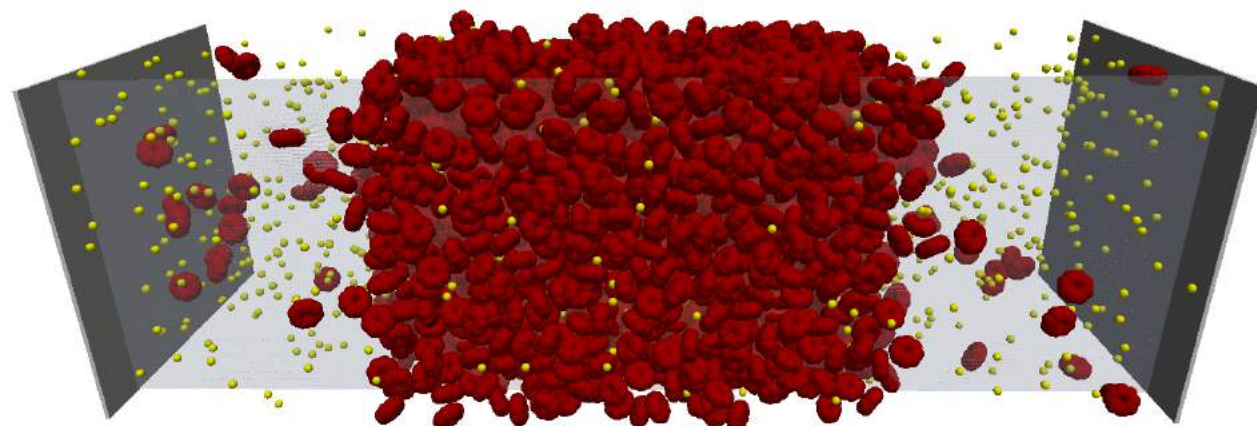



Cloud-based simulation of desalination systems powered by renewables



EXPERIMENT #915 HIGHLIGHTS
Industry Sector: **Renewable Energy**
Country: **Greece**
Software used: **TRNSYS, GenOPT**

ORGANIZATIONS

PHOTOVOLTAIC is a Greek SME, providing innovative solutions in water desalination coupled with renewable energy. THE AGRICULTURAL UNIVERSITY ATHENS focuses research in agro-nutrition, environmental ecology and agricultural economics. ARCTUR participated as an HPC Provider. VERTOYO from Greece, is an expert for implementation of integration of advanced technology services.

End User	Domain Expert	ISV	HPC Provider
www.photovoltalic.gr	www2.aua.gr/en	www.vertoyo.com	www.arctur.si

THE CHALLENGE

Based on the current industrial state of the art, the design process of RE-powered desalination systems takes place in two distinct steps. Step 1 includes the design of the reverse osmosis desalination system and Step 2 includes the design of the renewables system based on the desalination unit designed in Step 1. This approach using two distinct steps leads to non-optimized systems.

BUSINESS IMPACT

The solution (named DESAL) is expected to tap into the growing desalination market and manage to get an important share as far as design and sizing software is concerned. PHOTOVOLTAIC will be using DESAL in order to provide cost-effective turn-key solutions to customers worldwide and also through the network of the PHAESUN associated companies, to which PHOTOVOLTAIC belongs and which has presence worldwide across four continents. Moreover, the expected collaborations with 3rd party desalination and renewables SMEs, as well as private end users and public sector users will further increase DESAL's utilization and market share.

BENEFITS

- Depending on the individual case the new approach leads Photovaltaic to the design of systems featuring a decrease in the water production cost ranging from 5% to over 40%.
- The new approach can increase production of water by more than 40% without changing core properties of the system.





ICT Innovation for Manufacturing SMEs
www.i4ms.eu



Seventh Framework Programme
www.cordis.europa.eu/fp7



Horizon 2020
www.ec.europa.eu/programmes/horizon2020/



European Commission
www.ec.europa.eu

The research leading to these results has received funding from the European Union Seventh Framework Programme under grant agreement No 609029 and from the European Union's Horizon 2020 research and innovation programme under grant agreement No 680481.

This publication does not represent the opinion of the EC and the EC is not responsible for any use that might be made of information appearing herein.

For further information, please visit:



www.fortissimo-project.eu

Follow us on:



www.linkedin.com/groups/5096901



www.twitter.com/fortissimopro

www.fortissimo-project.eu

S S

